

34-02-001, Air Conditioning, without independent heating, without navigation system

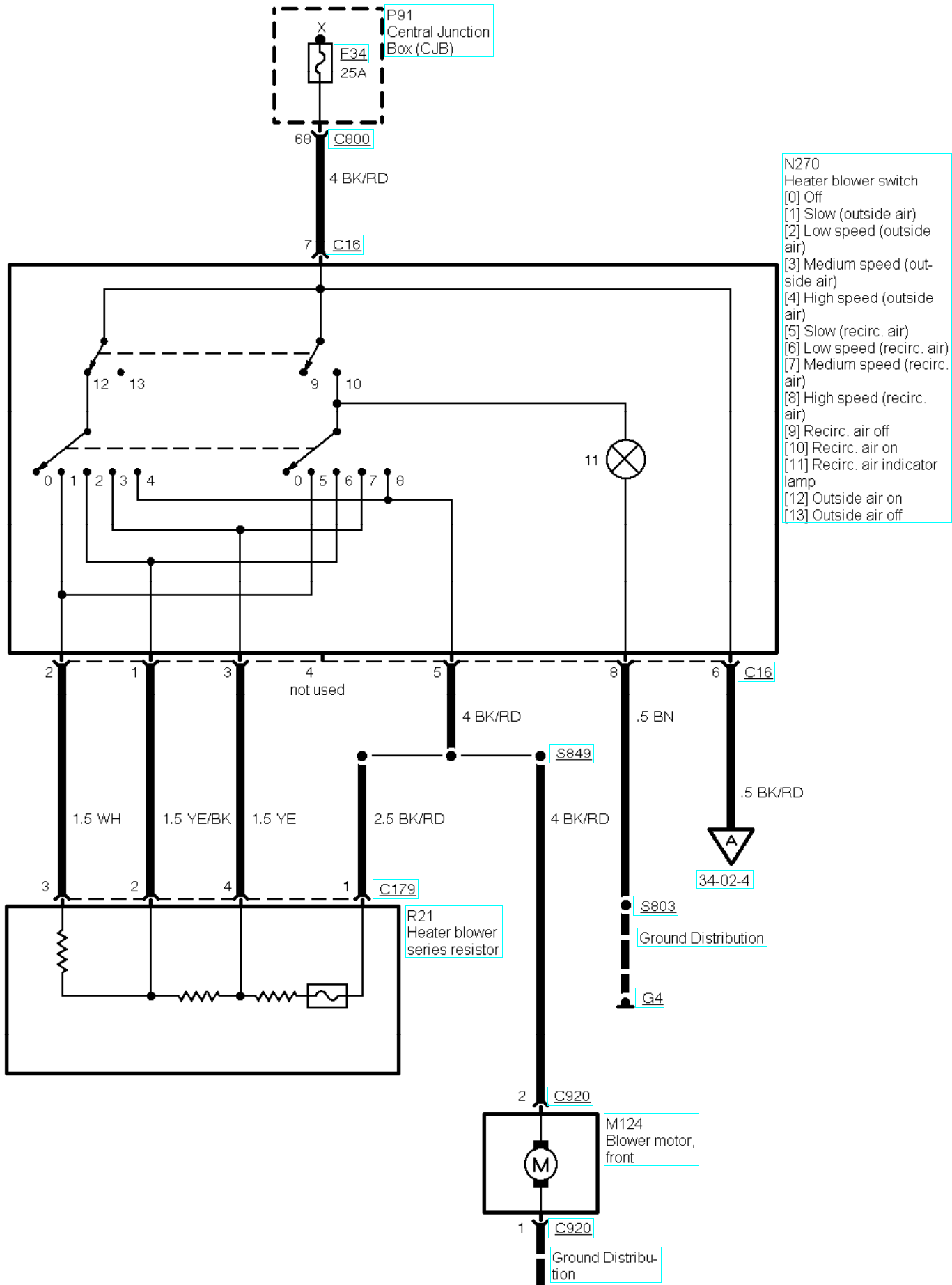

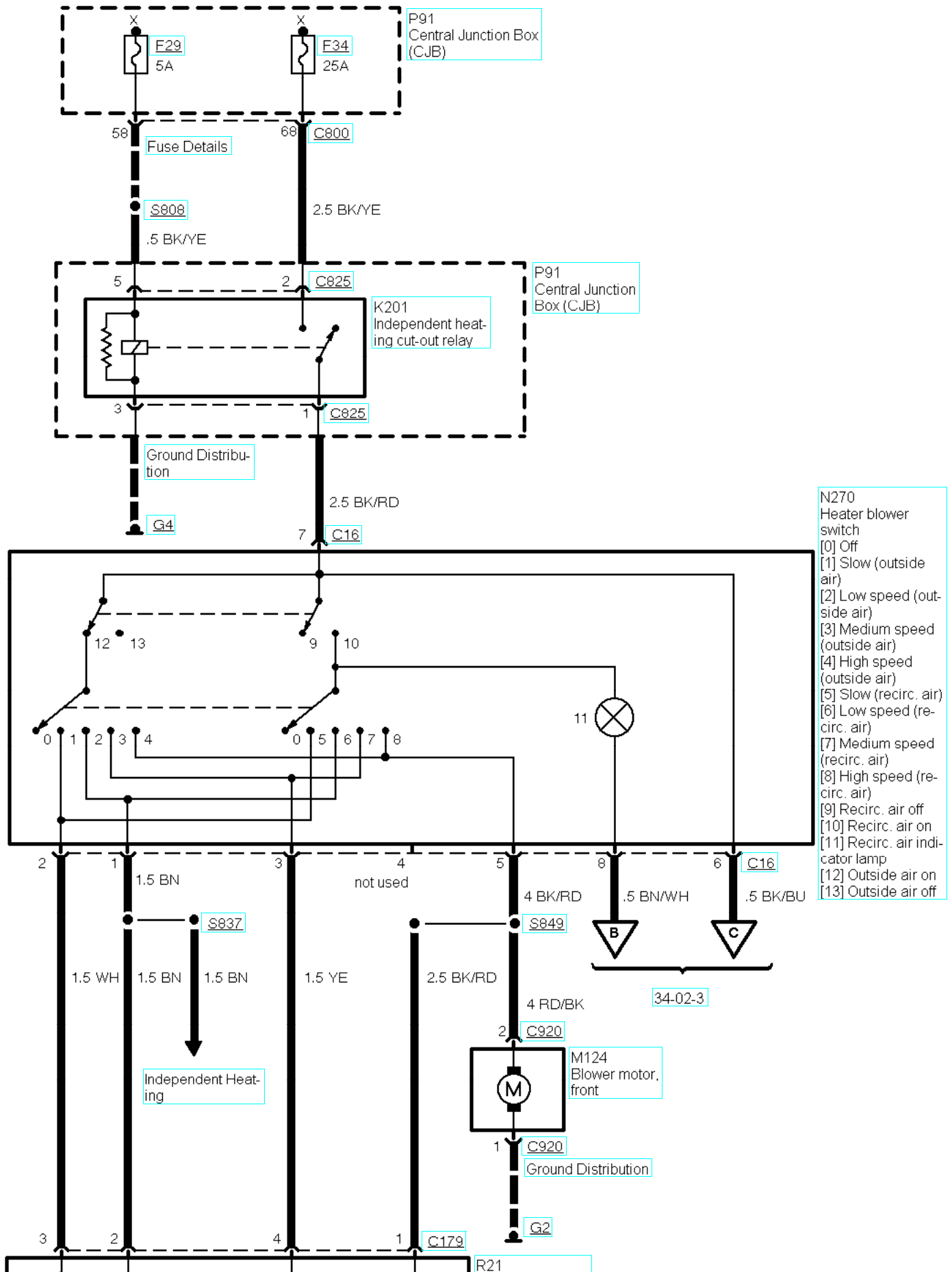

34-02-002, Air Conditioning, with independent heating, without navigation system

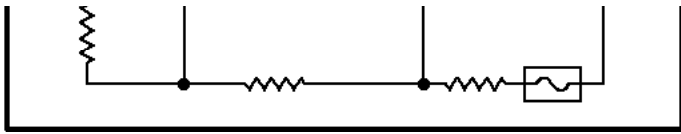



Heater blower series resistor

34-02-003, Air Conditioning, with independent heating

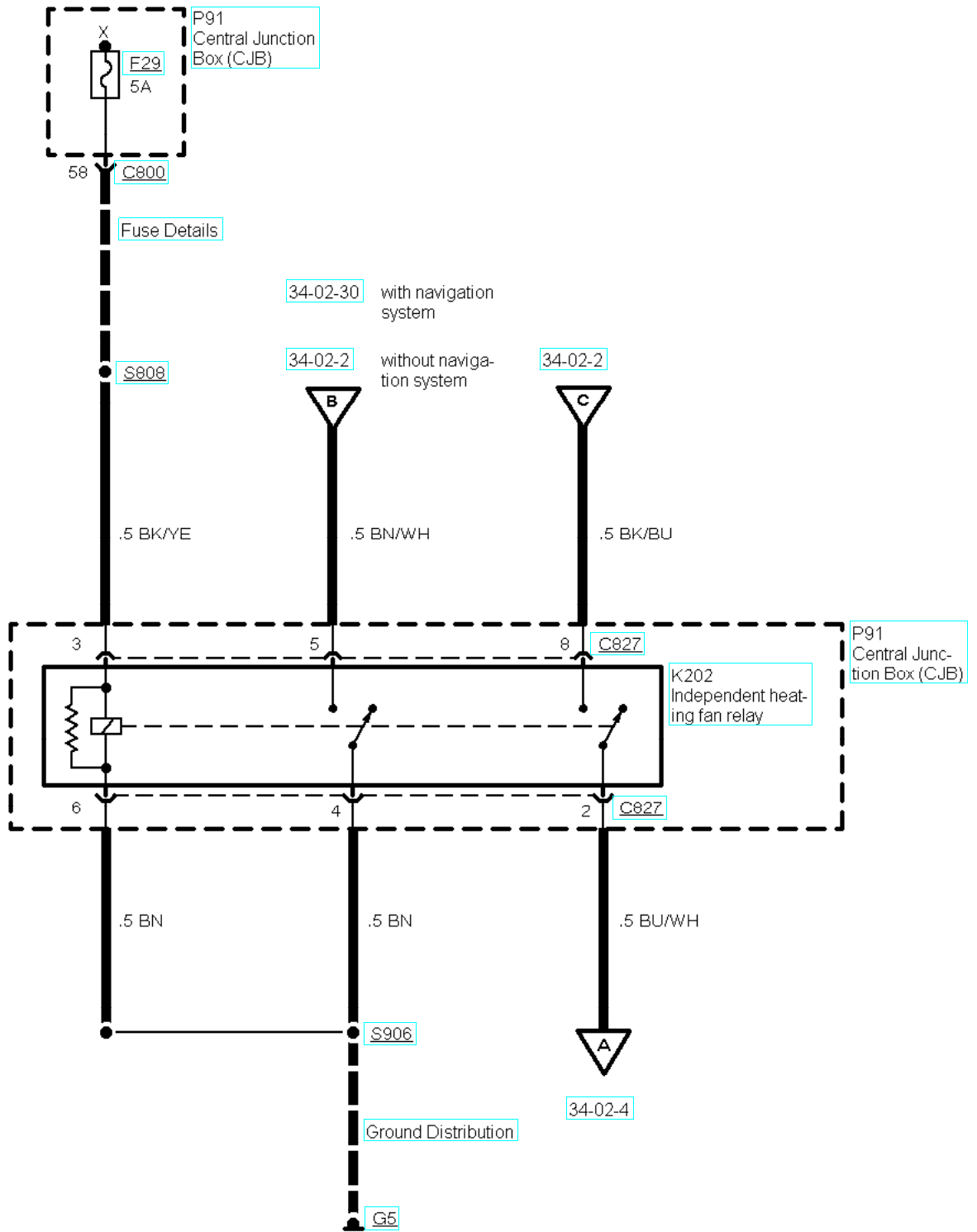

34-02-004, Air Conditioning

tion



G4

34-02-21 2,3i DOHC manual transmission as of 11/98

34-02-24 2,3i DOHC automatic transmission before 10/98

34-02-26 2,3i DOHC automatic transmission as of 11/98

34-02-005, Air Conditioning, 2,8i CD-V6

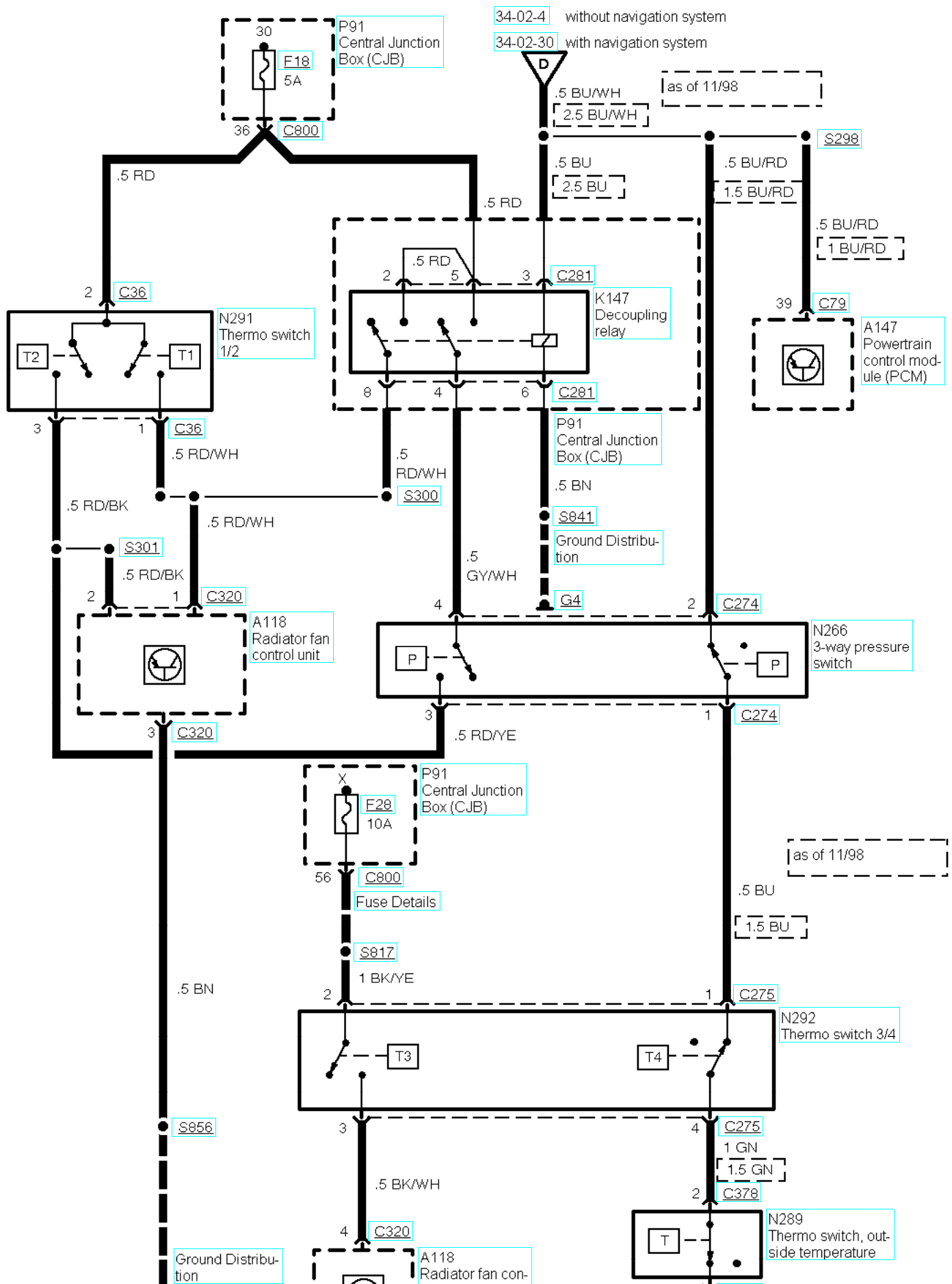

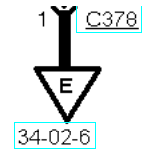
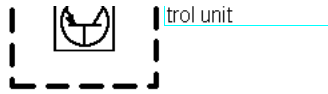

34-02-006, Air Conditioning, 2,8i CD-V6

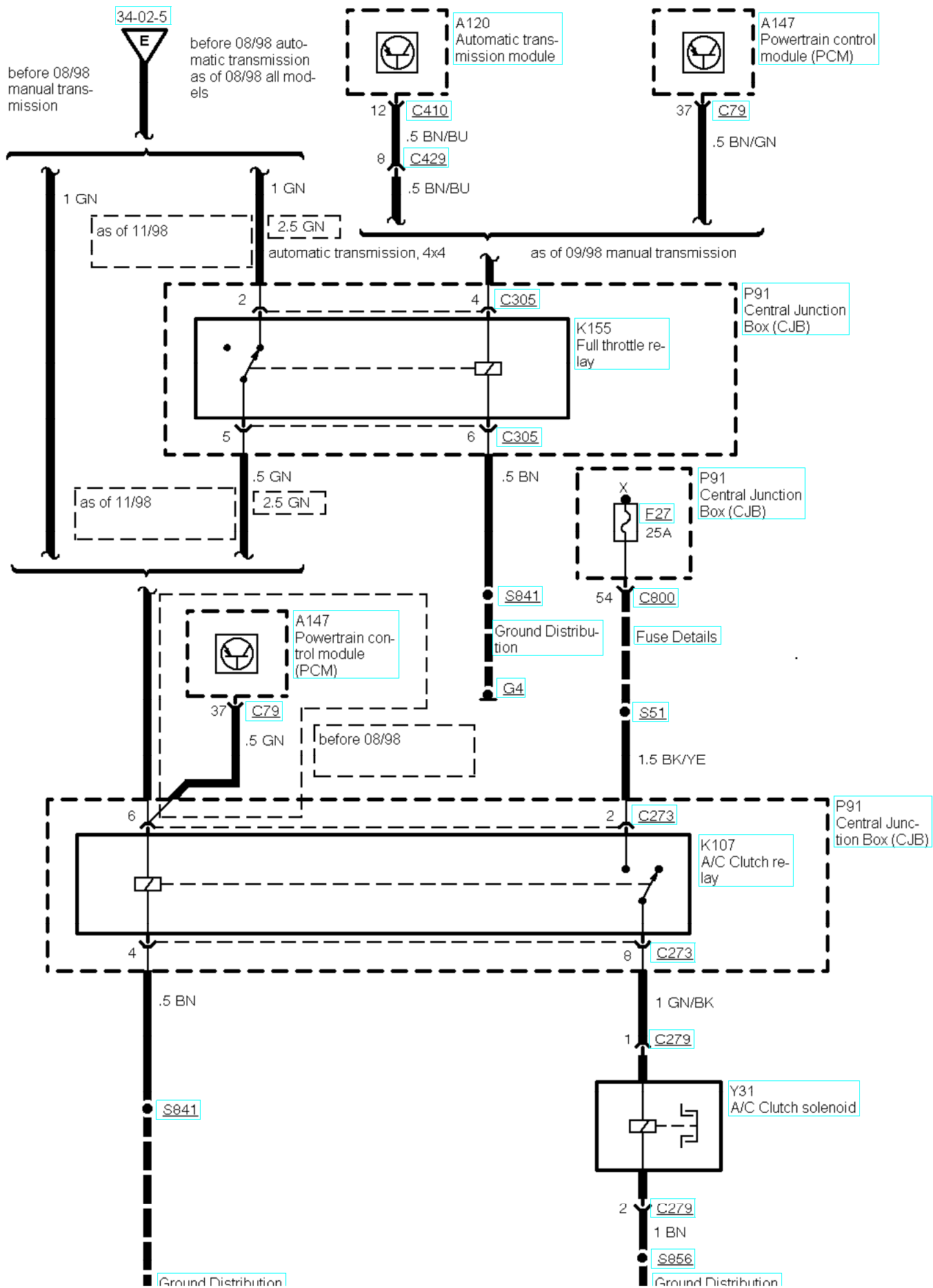

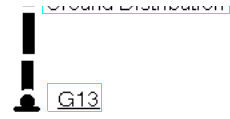
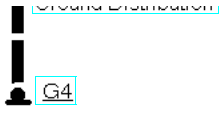

34-02-007, Air Conditioning

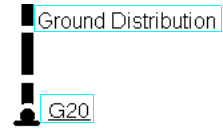
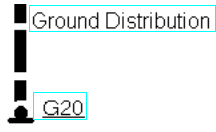

34-02-008, Air Conditioning

2,8i CD-V6

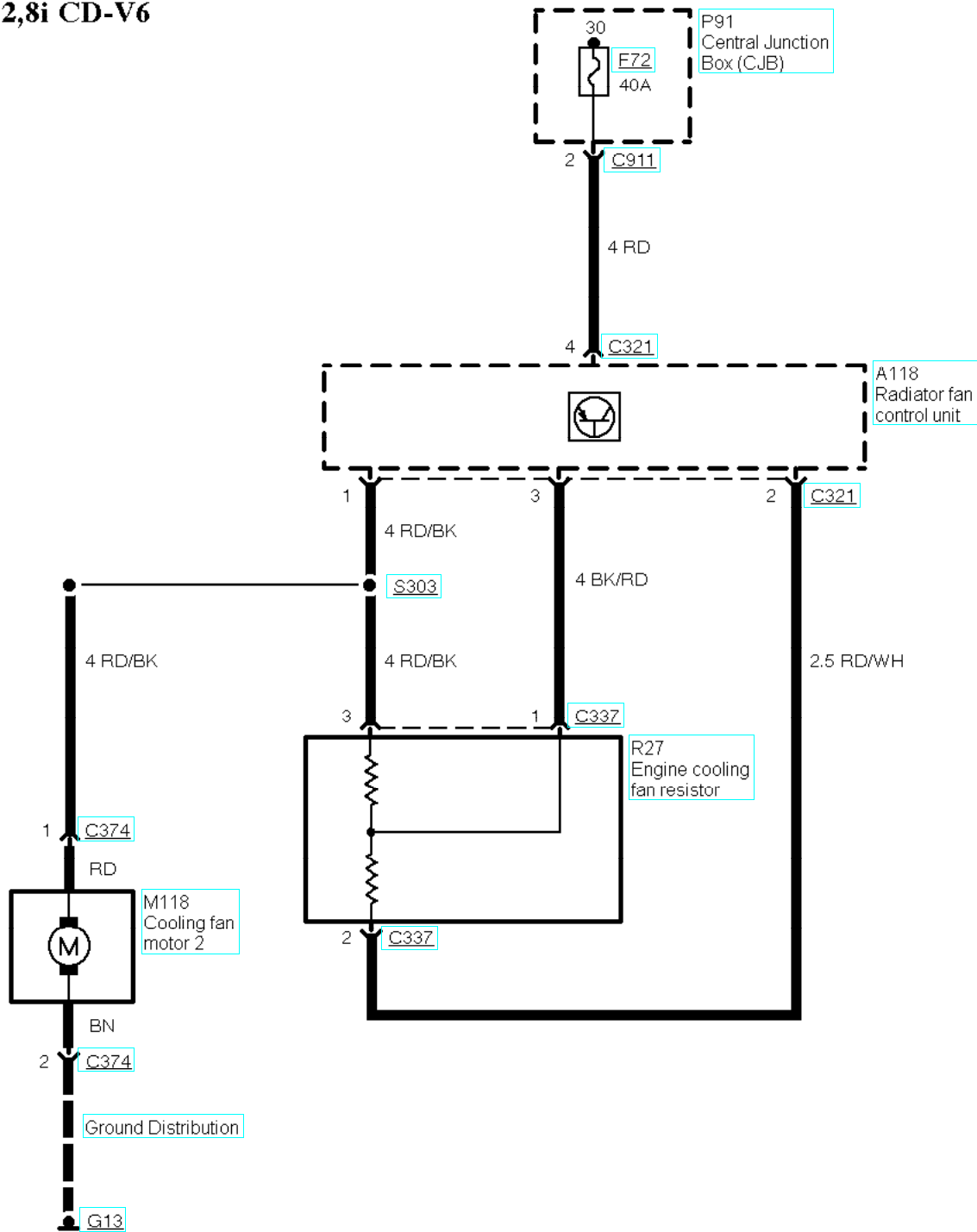

34-02-009, Air Conditioning, 66kW TDI

V
34-02-10



34-02-010, Air Conditioning, 66kW TDI

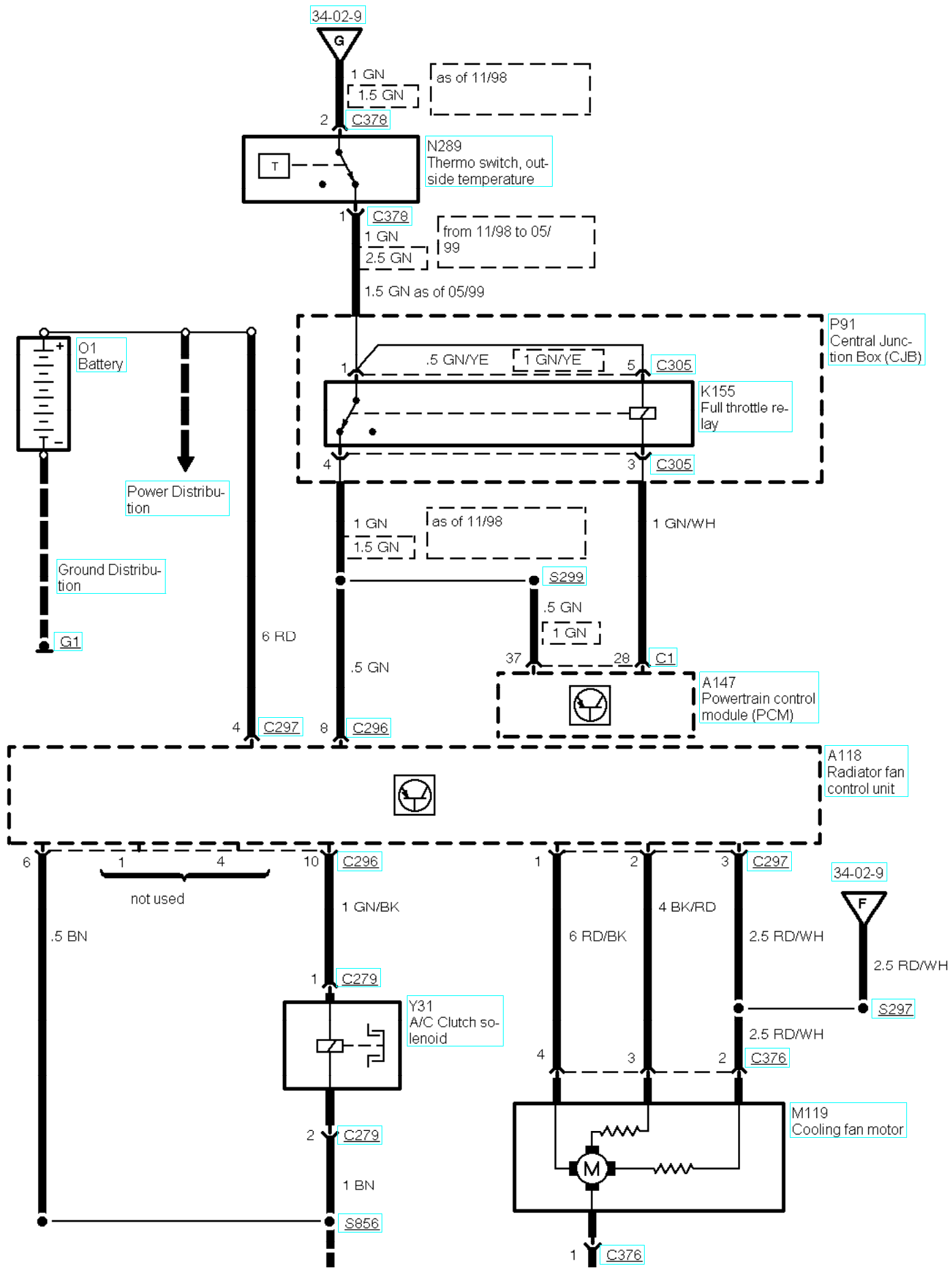

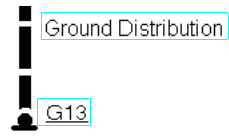
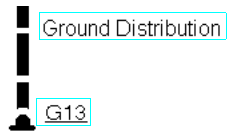

34-02-011, Air Conditioning, 81kW TDI

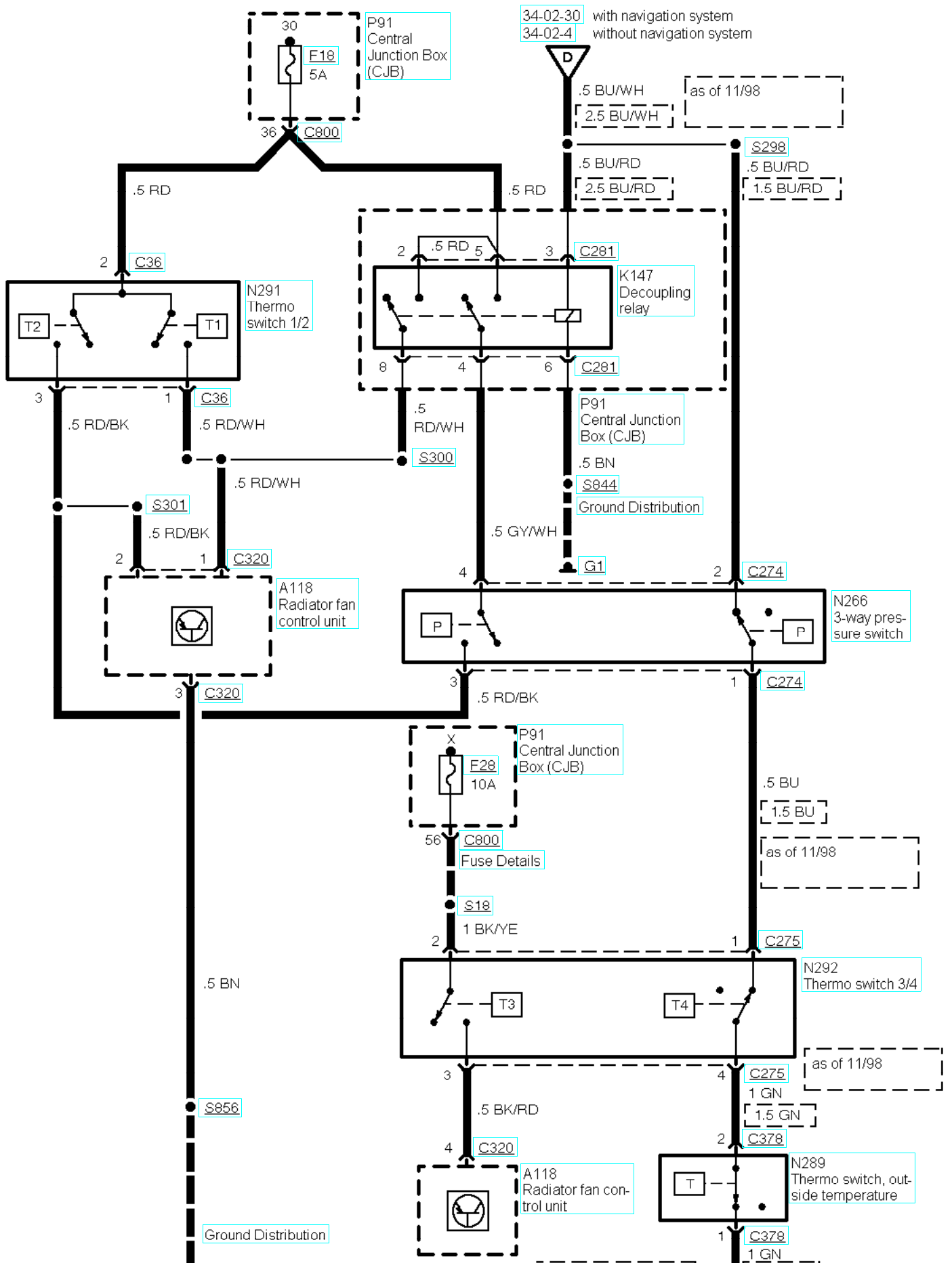

i
G13

from 11/98 to 05/99

2.5 GN
1.5 GN as of 05/99
H

34-02-12

34-02-012, Air Conditioning, 81kW TDI

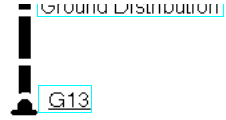
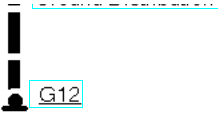

34-02-013, Air Conditioning, 81kW TDI

■ Ground Distribution

G13

34-02-014, Air Conditioning, 81kW TDI

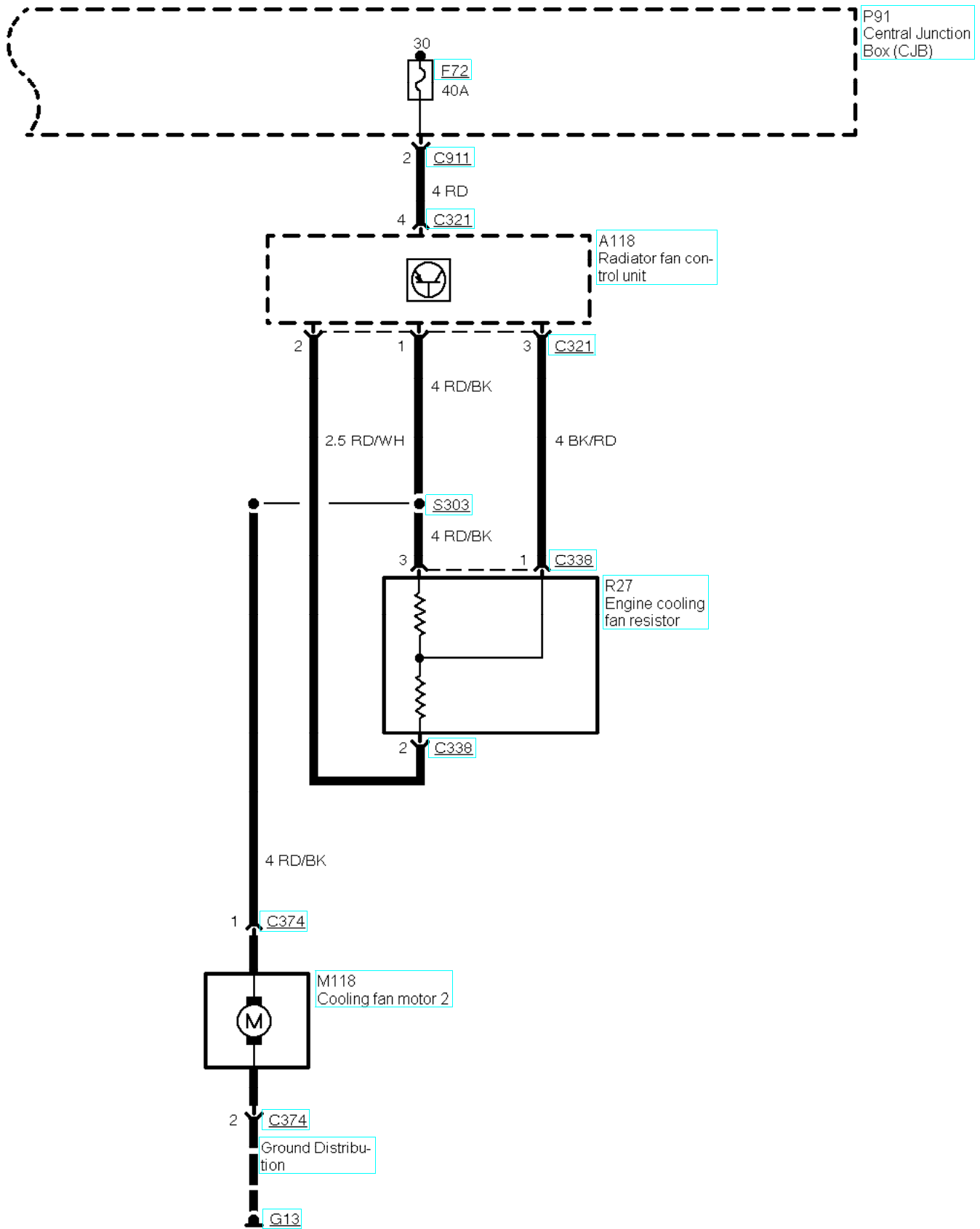

P91
Central Junction
Box (CJB)

F72
40A

C911

4 RD

C321

A118
Radiator fan control
unit

2

1

3

C321

4 RD/BK

2.5 RD/WH

4 BK/RD

S303

4 RD/BK

3

1

C338

R27
Engine cooling
fan resistor

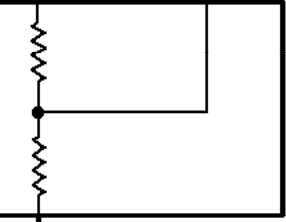

C338

4 RD/BK

1

C374

M118
Cooling fan motor 2

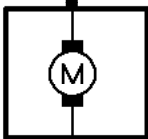

2

C374

Ground Distribu-
tion

G13

34-02-015, Air Conditioning

2,0i DOHC

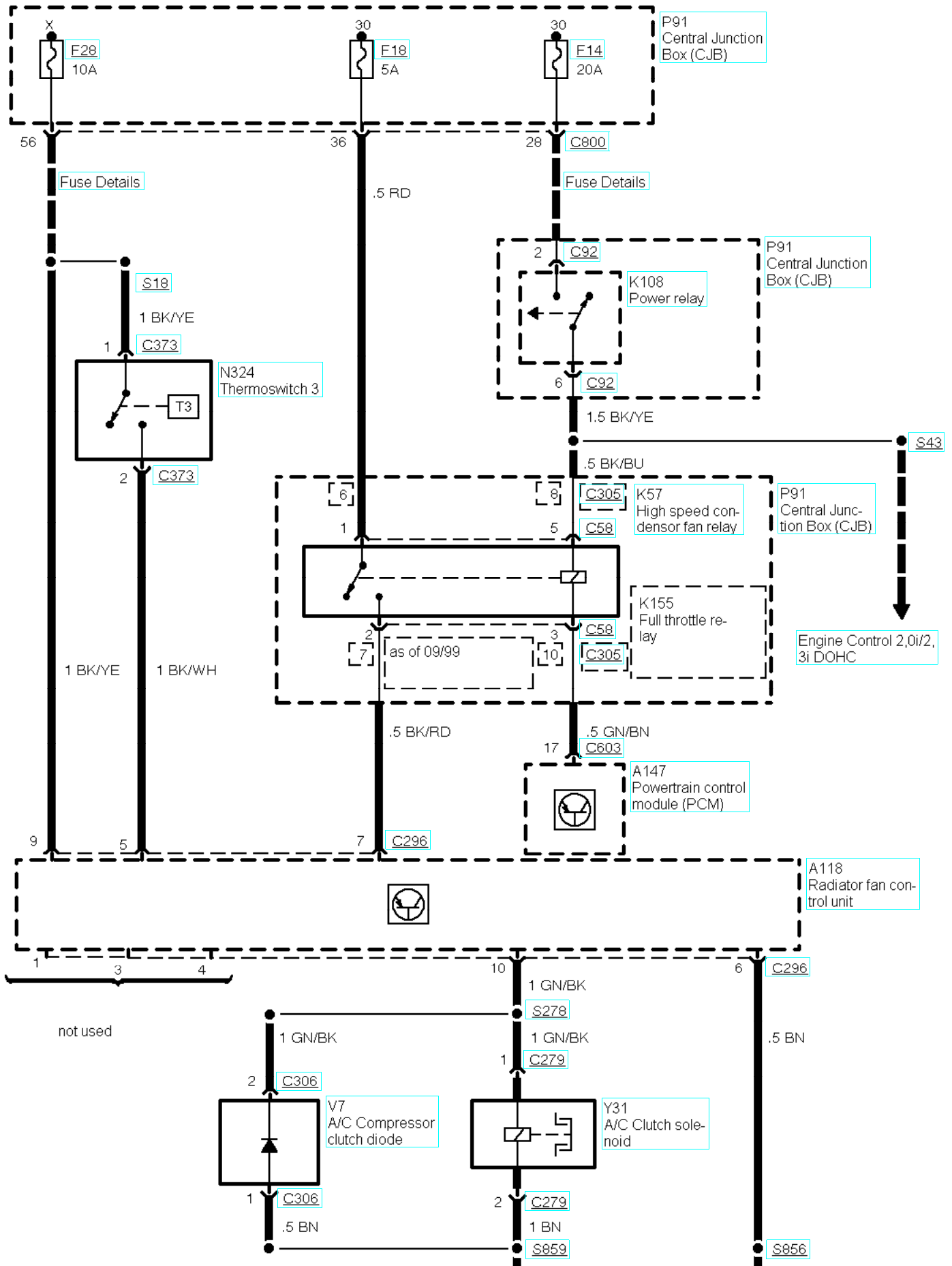

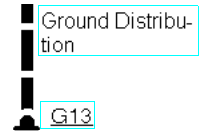
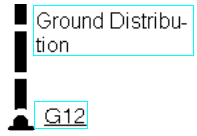

34-02-016, Air Conditioning, 2,0i DOHC

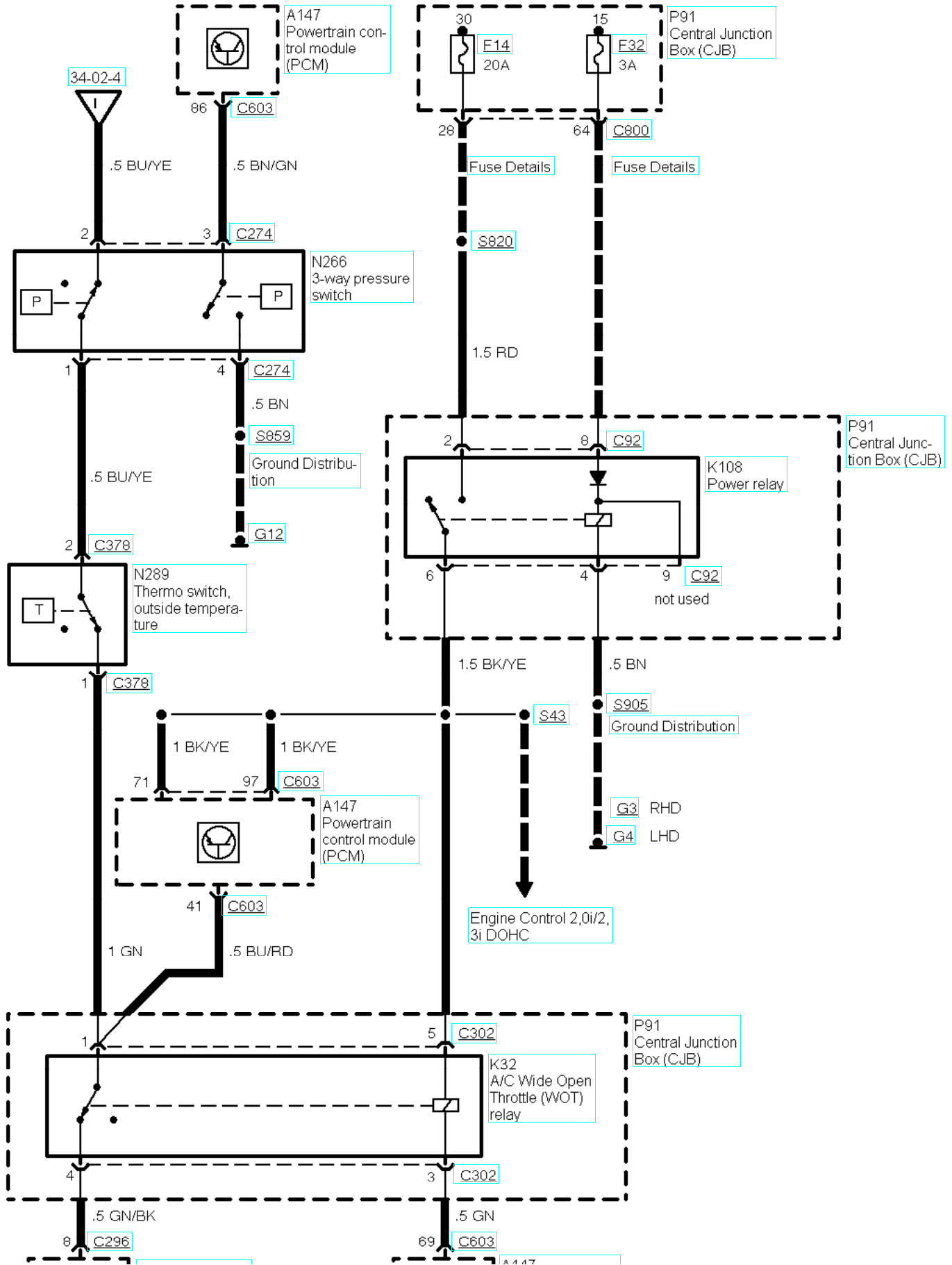

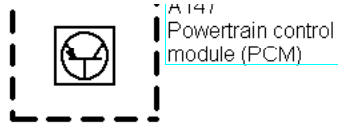
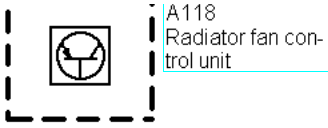

34-02-017, Air Conditioning, 2,0i DOHC

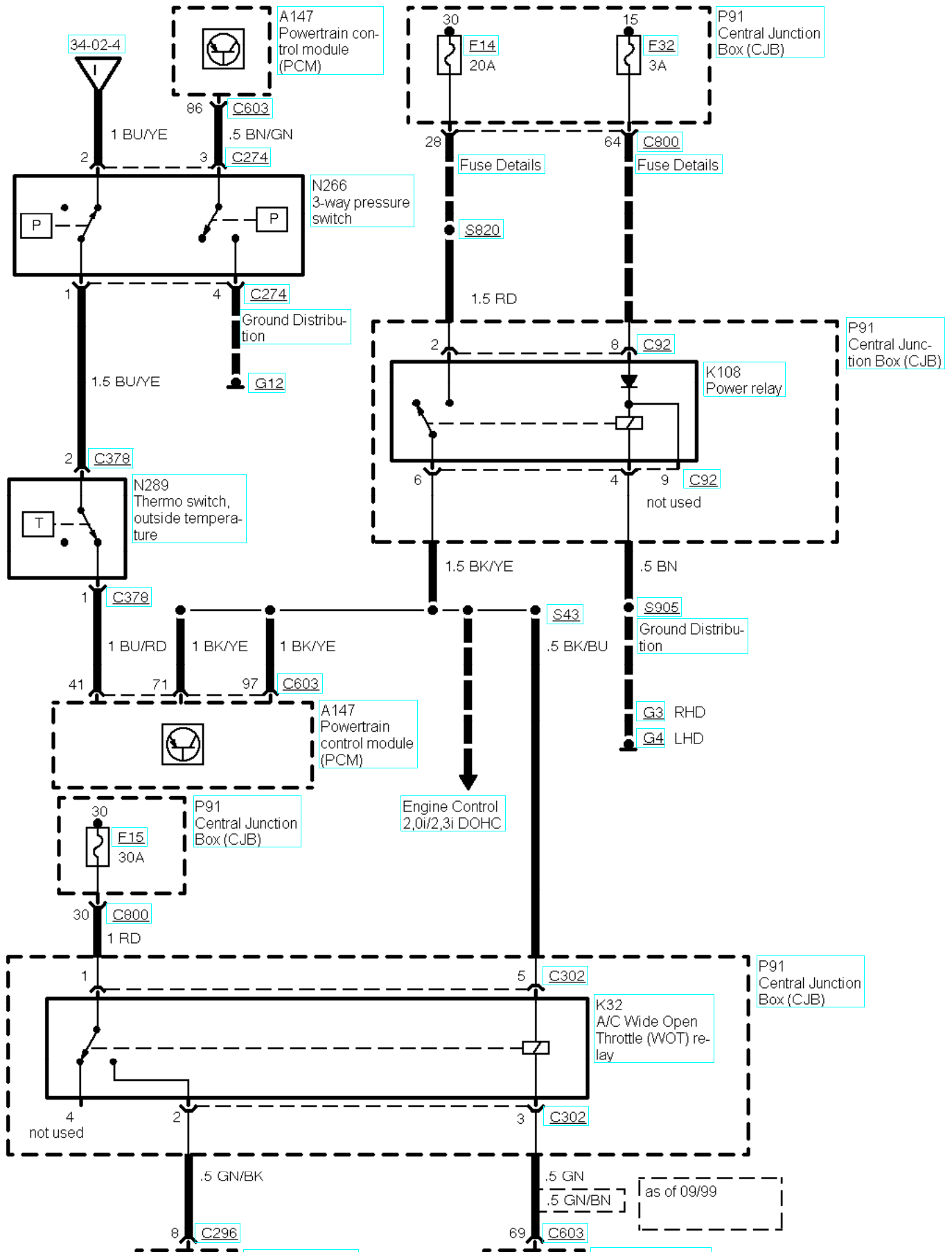

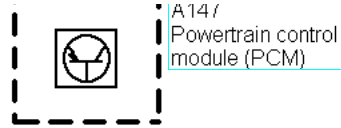
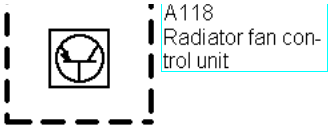

34-02-018, Air Conditioning



Powertrain
control module
(PCM)



Ground Distribution

G13

34-02-019, Air Conditioning, 2,3i DOHC, manual transmission

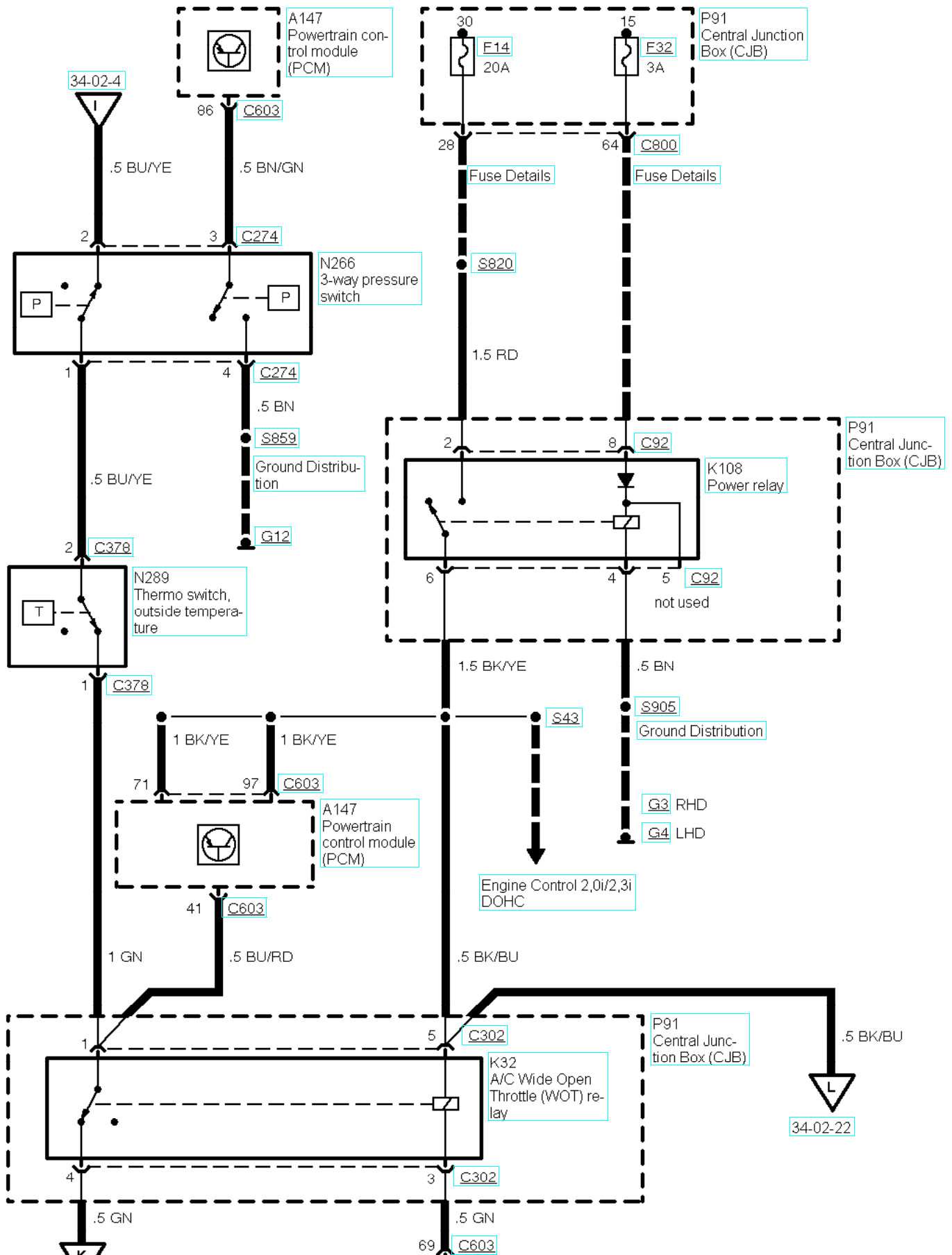

V
34-02-20

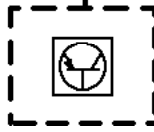

A147
Powertrain control
module (PCM)

34-02-020, Air Conditioning, 2,3i DOHC, manual transmission

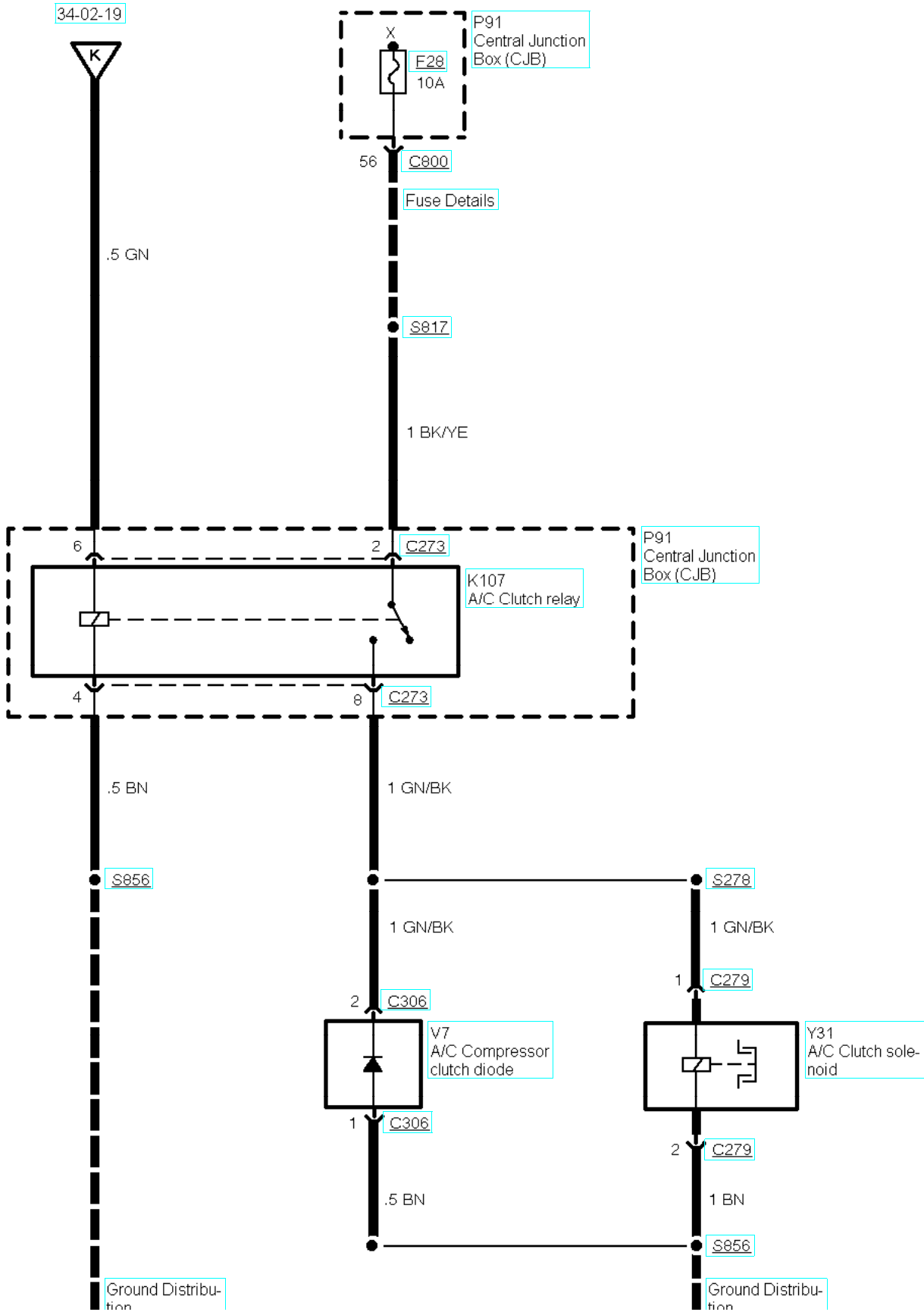

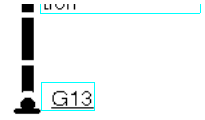
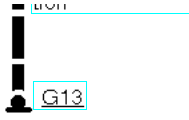

34-02-021, Air Conditioning, 2,3i DOHC, manual transmission

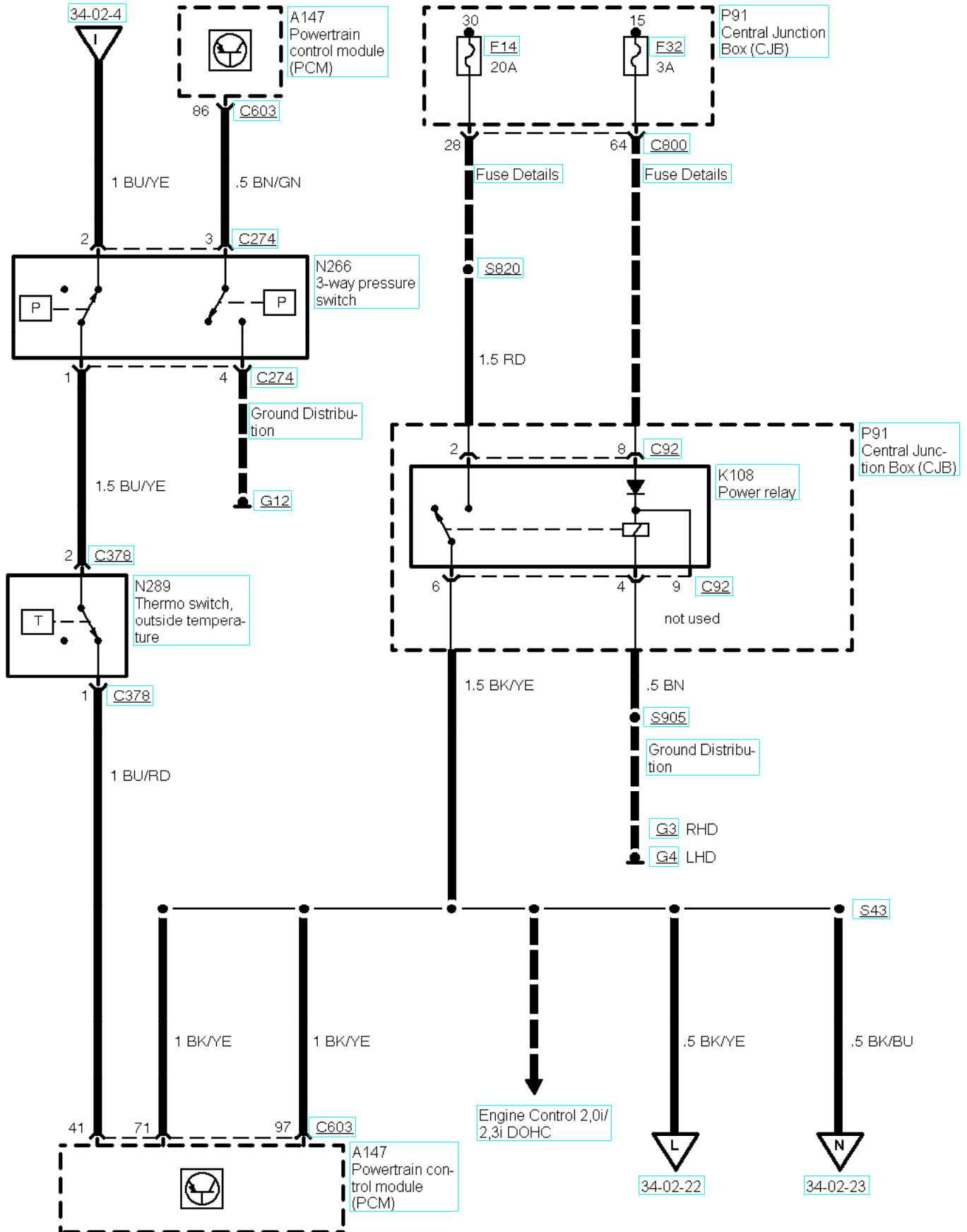

34-02-22

34-02-23

34-02-022, Air Conditioning, 2,3i DOHC, manual transmission

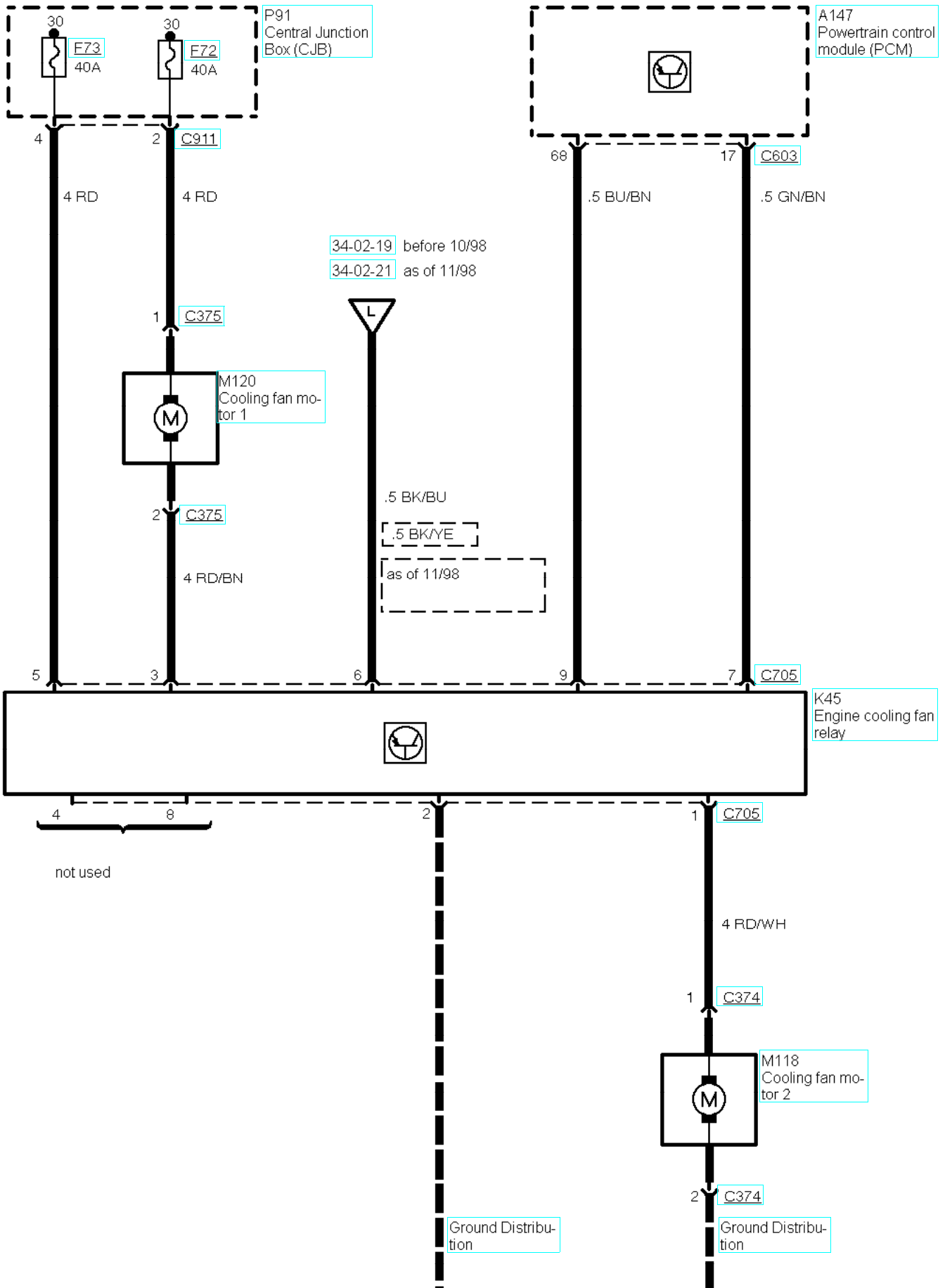

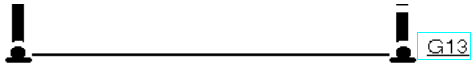

34-02-023, Air Conditioning, 2,3i DOHC

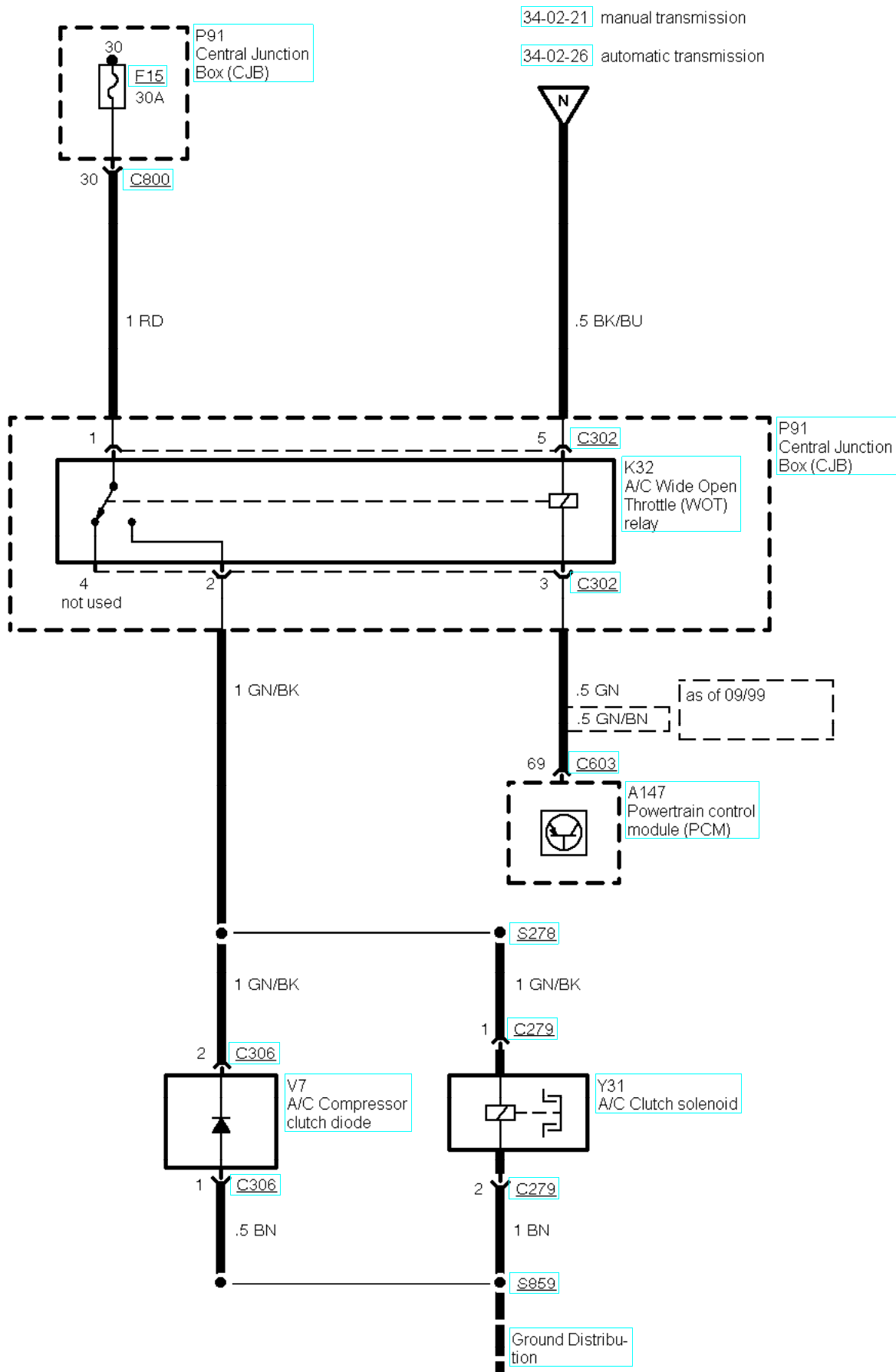



34-02-024, Air Conditioning, 2,3i DOHC, automatic transmission



34-02-25



A147
Powertrain control
module (PCM)

34-02-025, Air Conditioning, 2,3i DOHC, automatic transmission

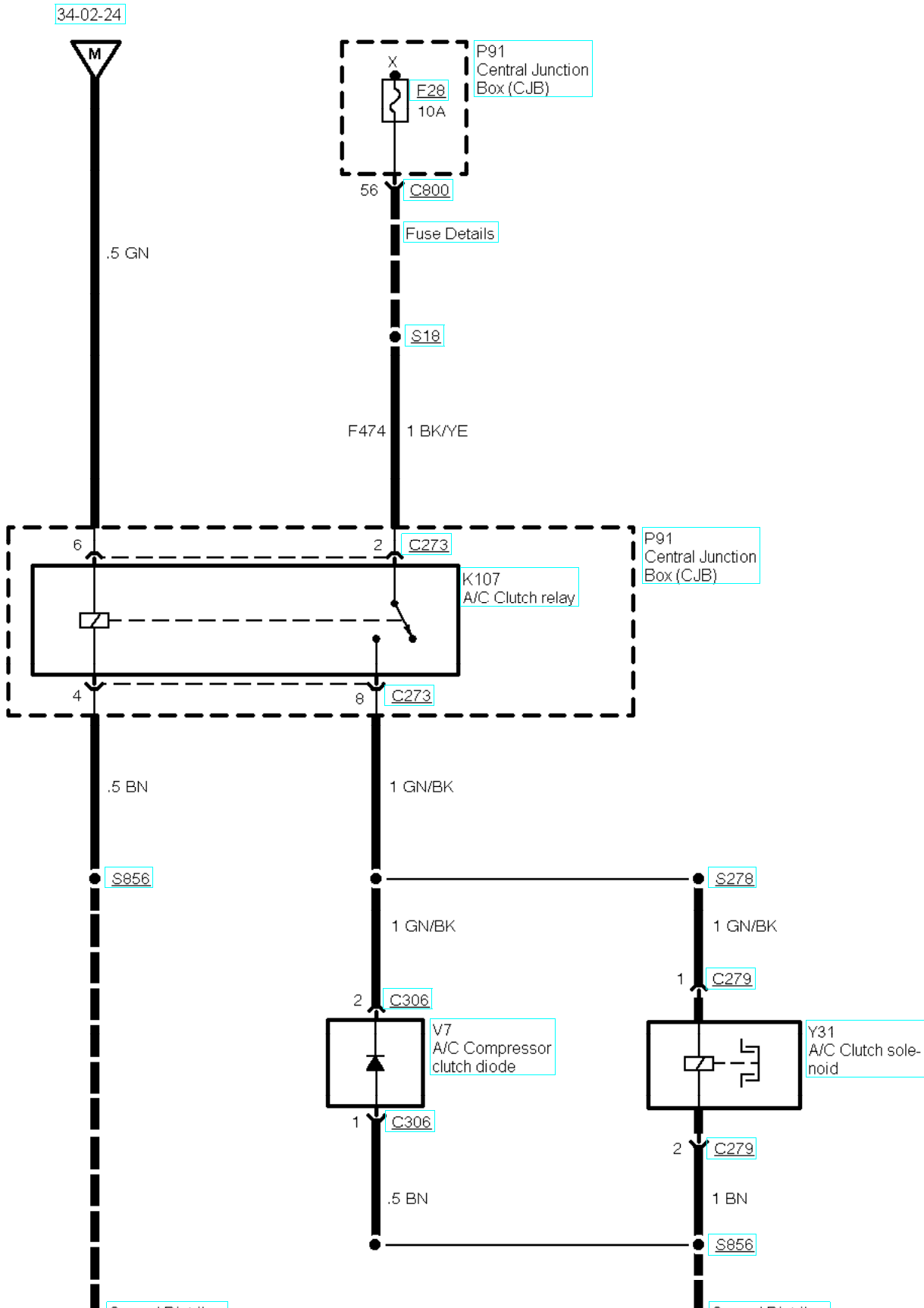

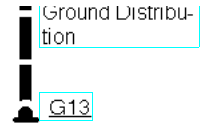
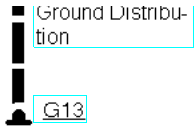

34-02-026, Air Conditioning, 2,3i DOHC, automatic transmission

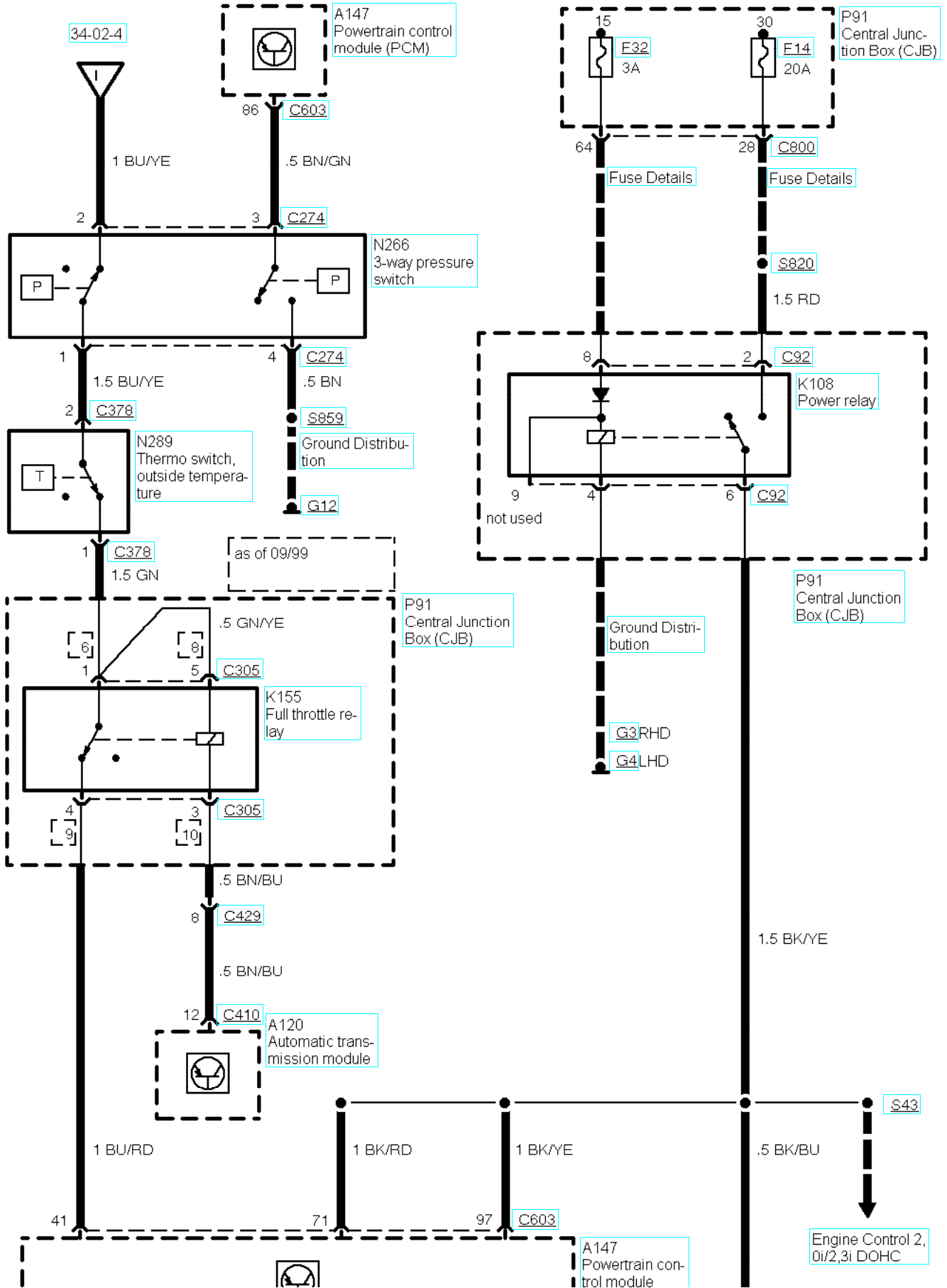



34-02-23

34-02-027, Air Conditioning, 2,3i DOHC, automatic transmission

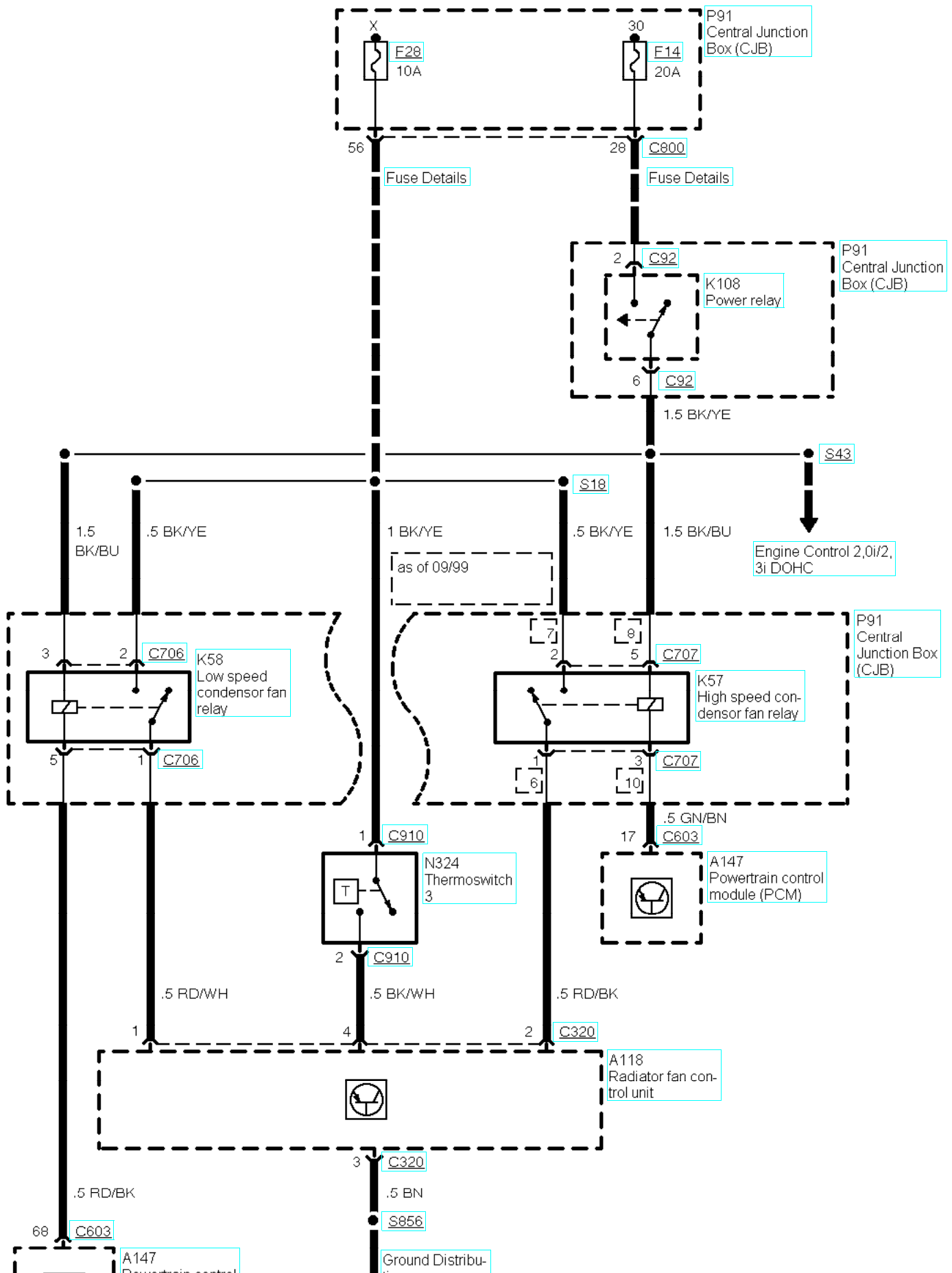

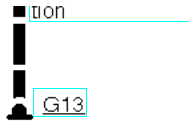
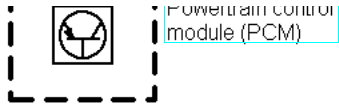

34-02-028, Air Conditioning, 2,3i DOHC, automatic transmission

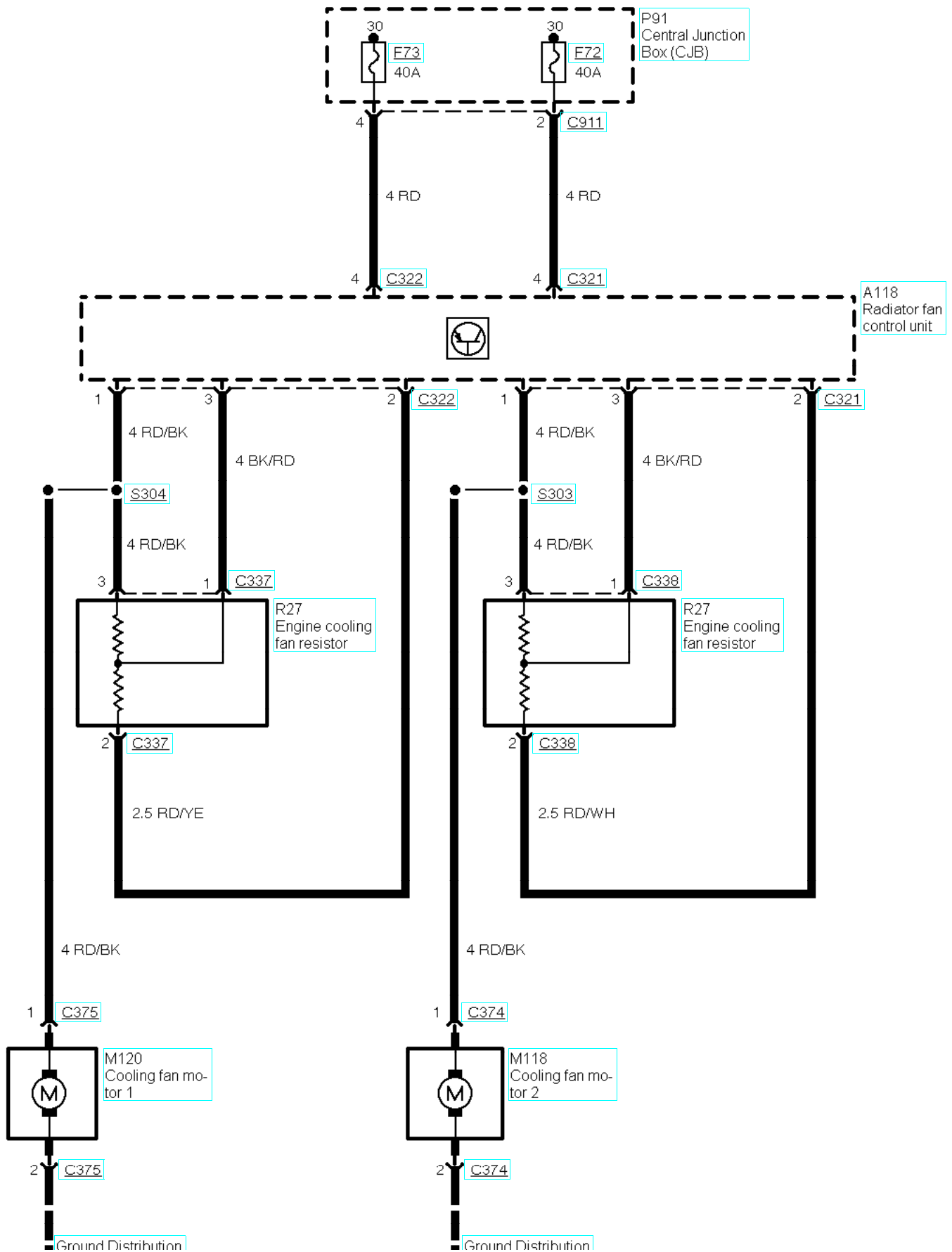

STANDA-STANDARDEN

G13

STANDA-STANDARDEN

G13

34-02-029, Air Conditioning, with navigation system

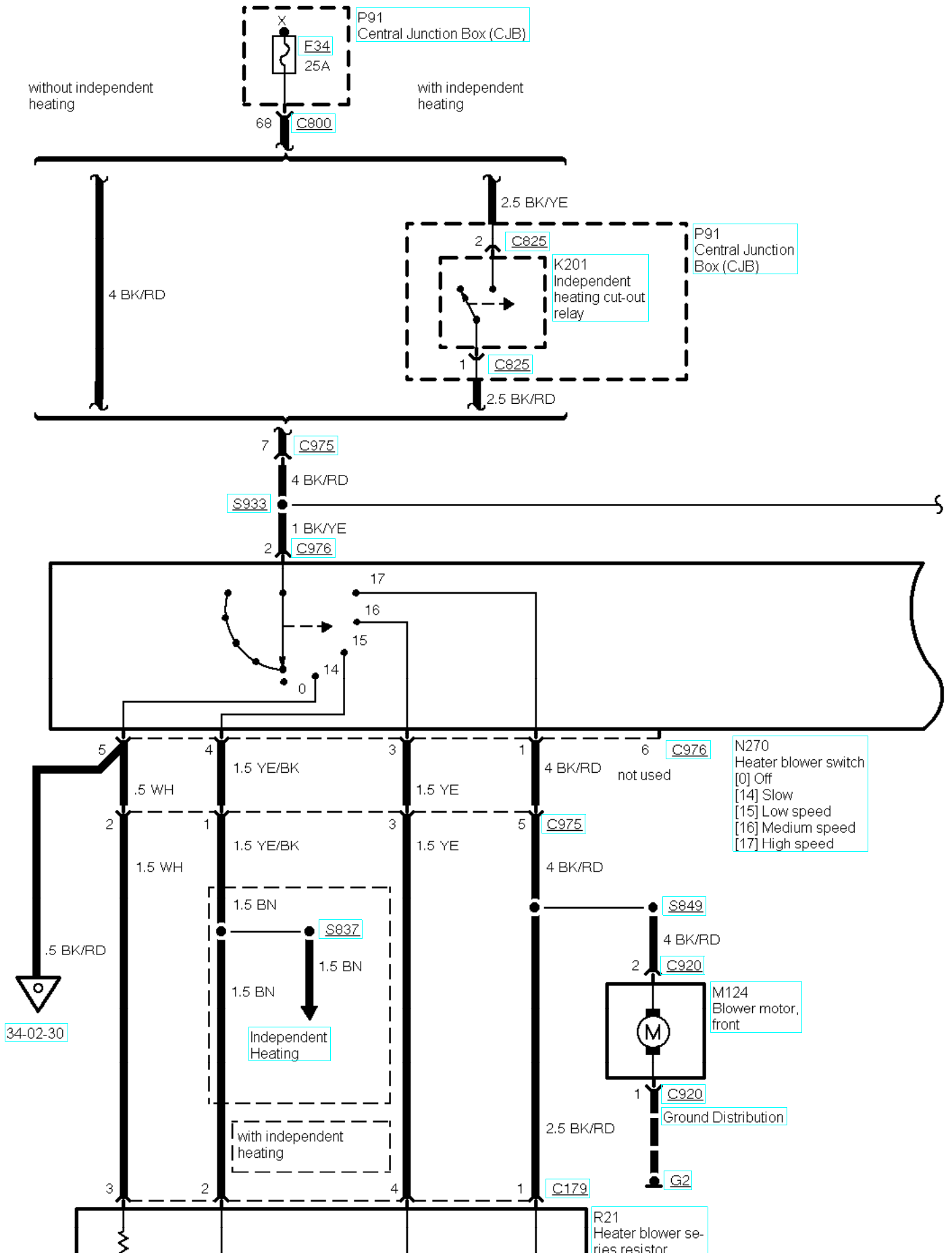

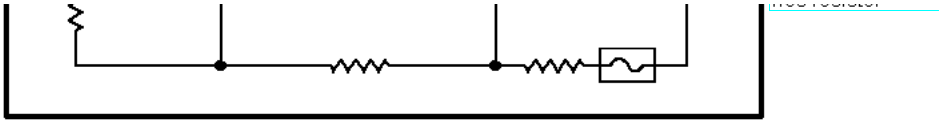

34-02-030, Air Conditioning, with navigation system

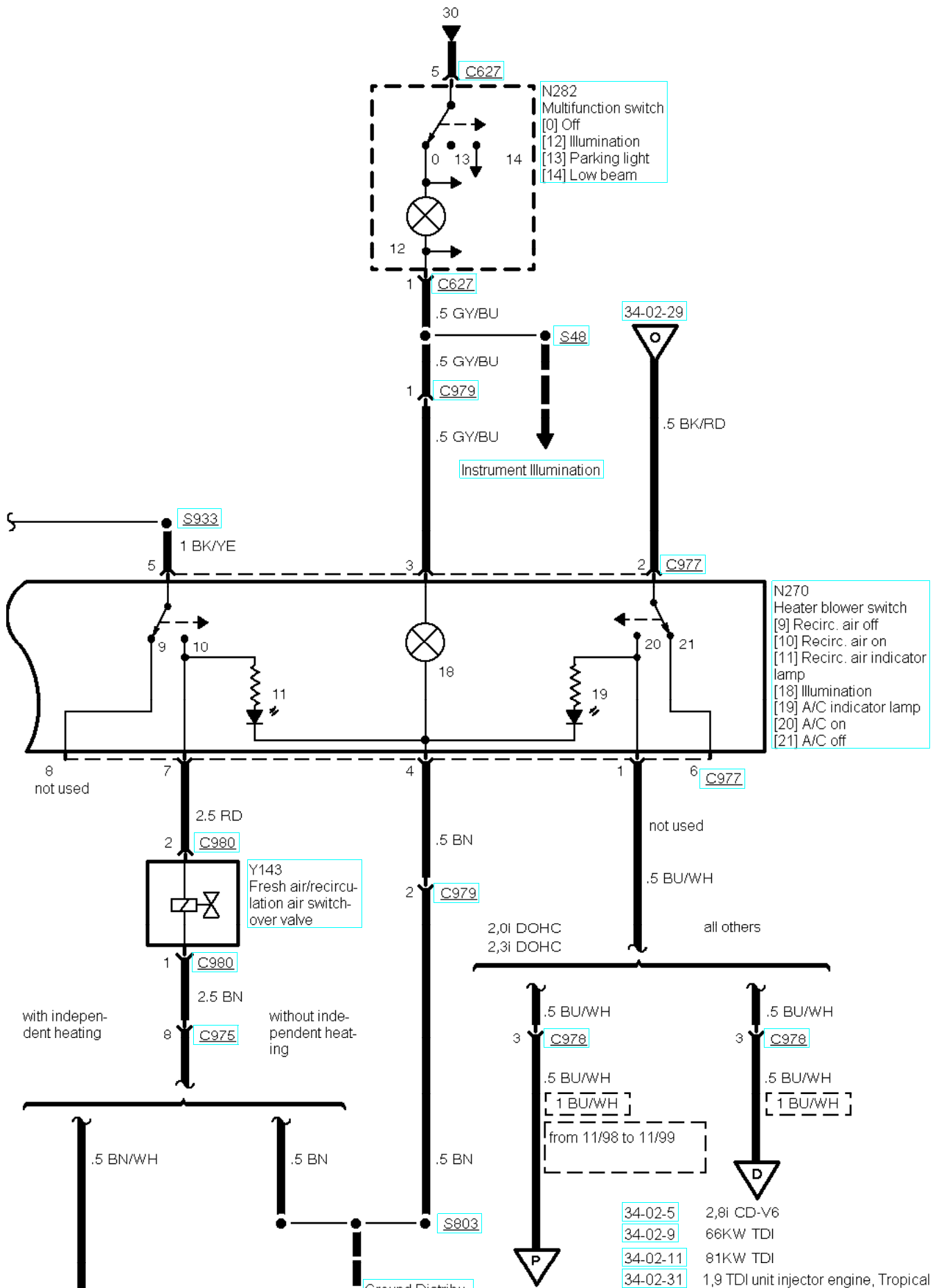



34-02-3

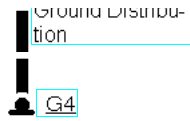

34-02-4

area

34-02-35

1,9 TDI unit injector engine, not tropical area

34-02-031, Air Conditioning, 1,9 TDI unit injector engine, Tropical area

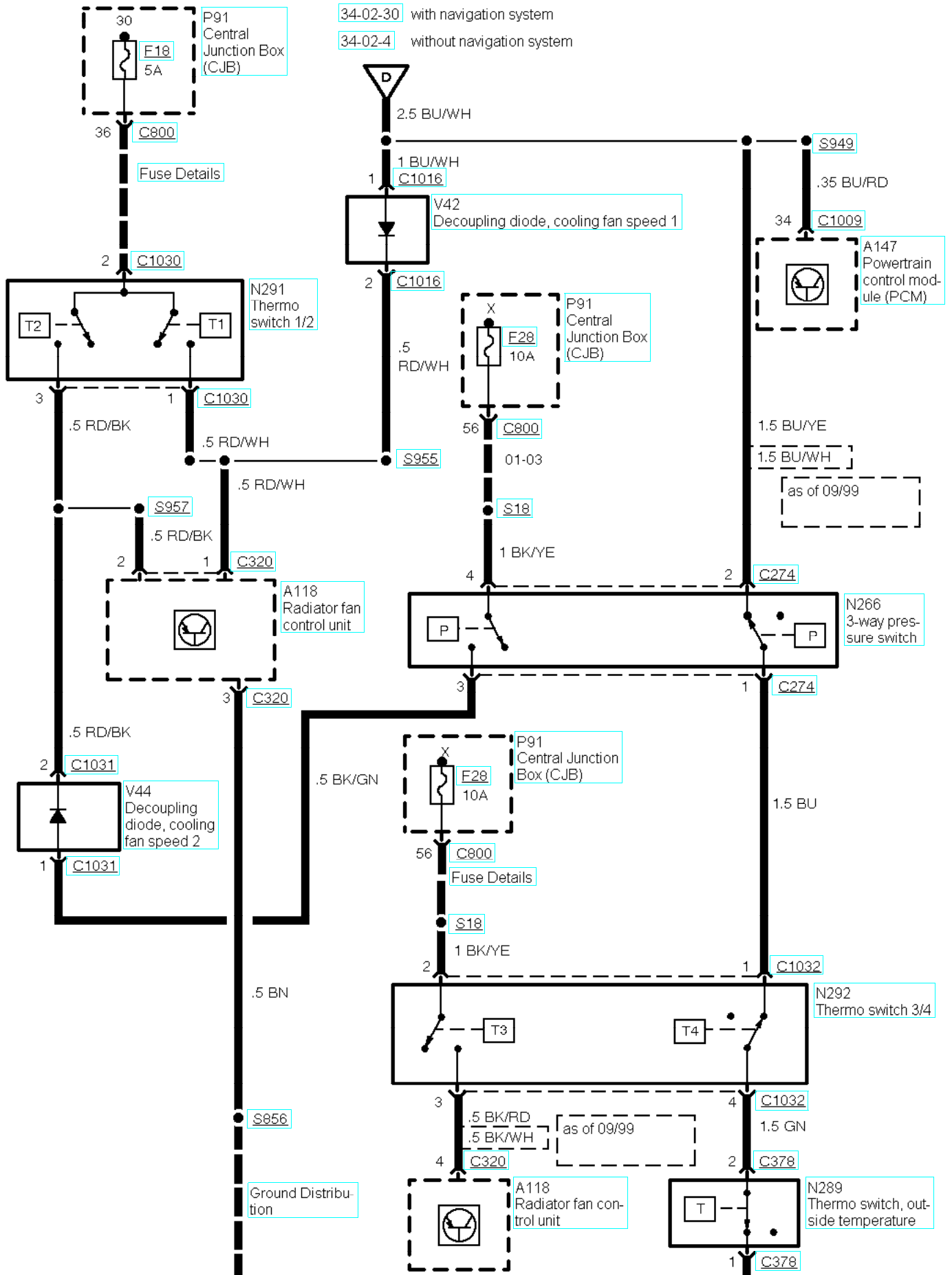

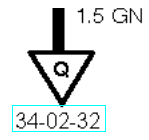

34-02-032, Air Conditioning, 1,9 TDI unit injector engine, Tropical area

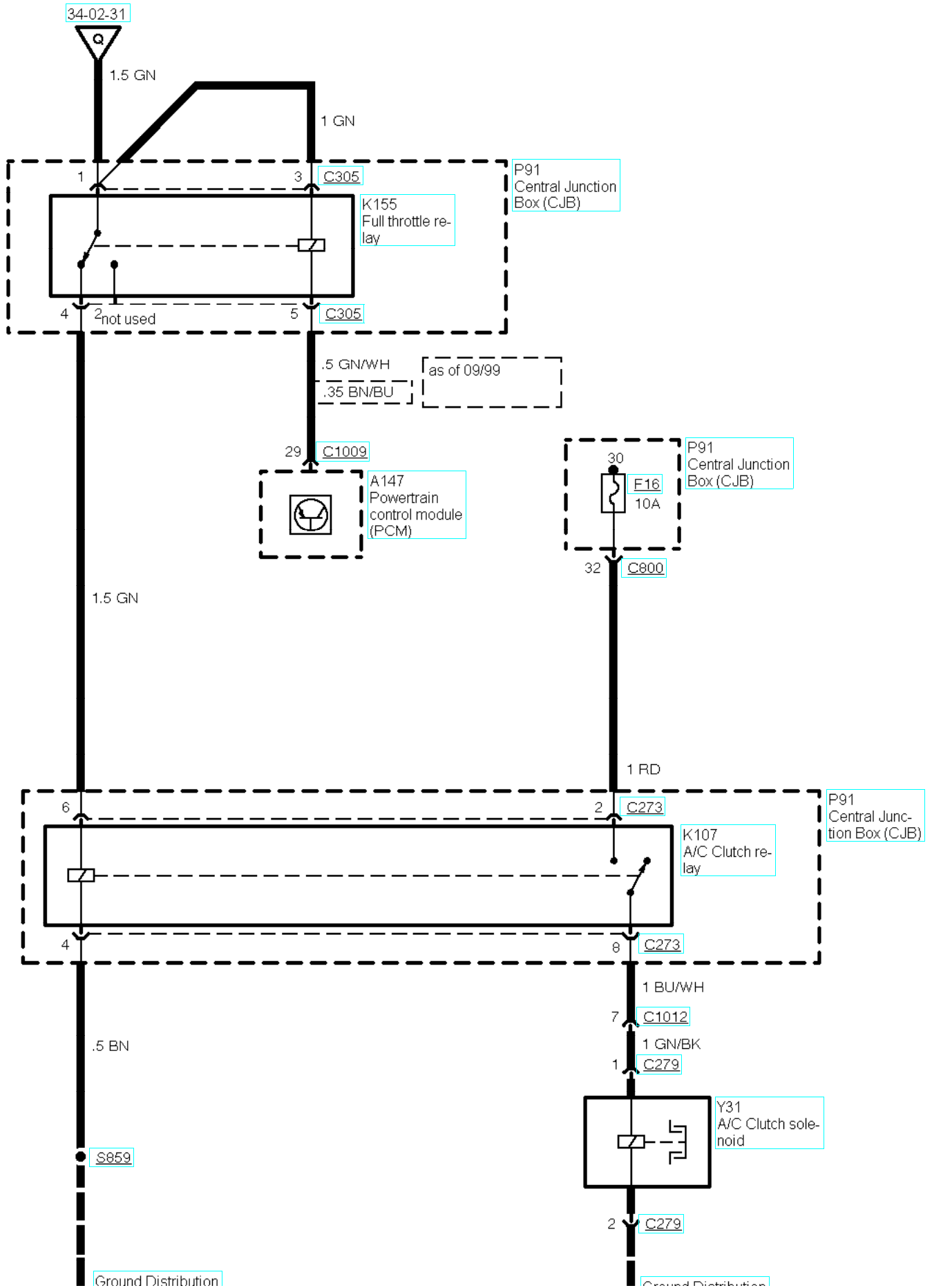

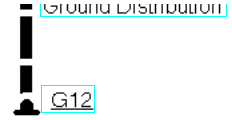
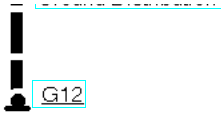

34-02-033, Air Conditioning, 1,9 TDI unit injector engine, Tropical area

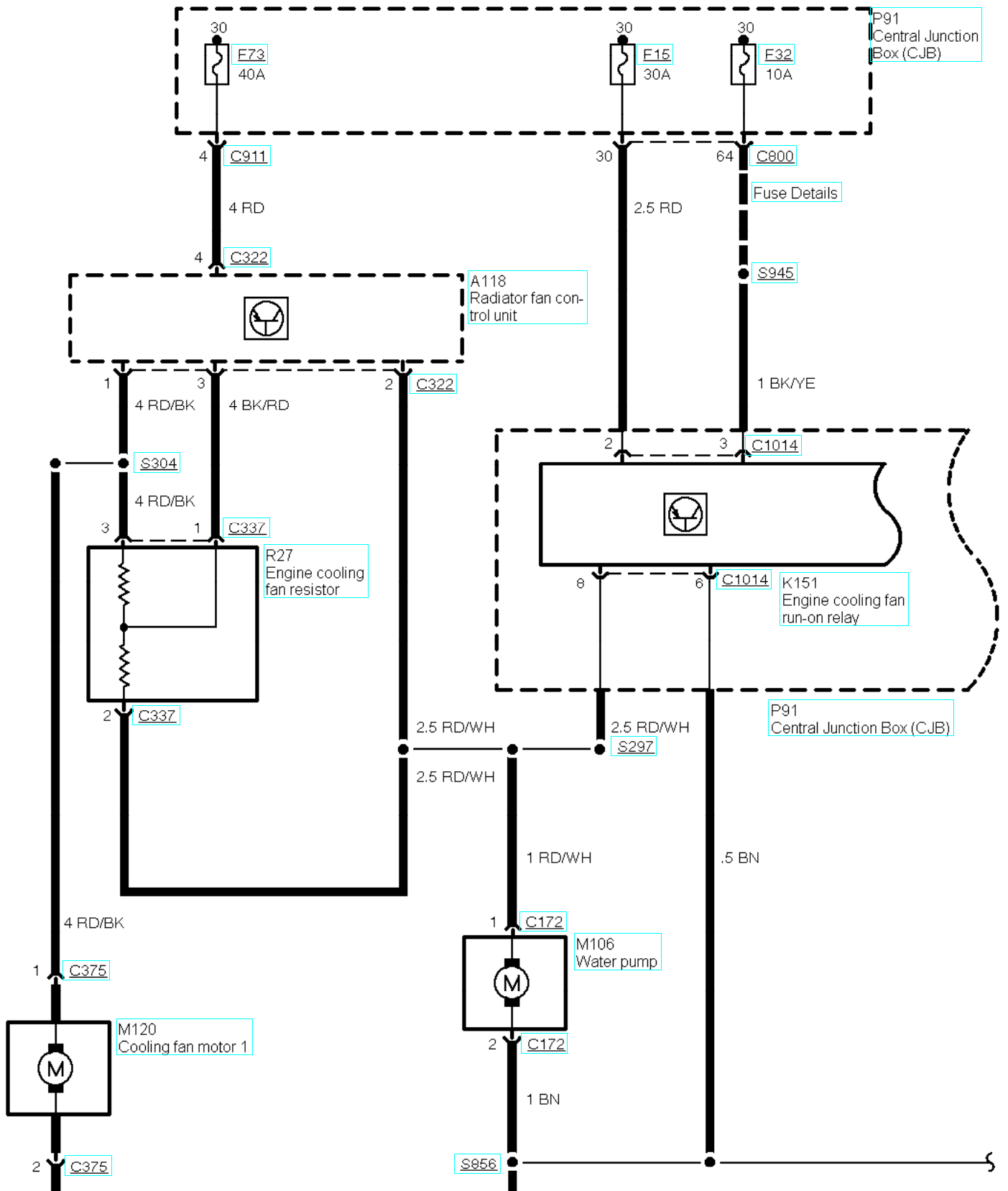

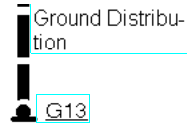
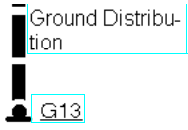

34-02-034, Air Conditioning, 1,9 TDI unit injector engine Tropical area

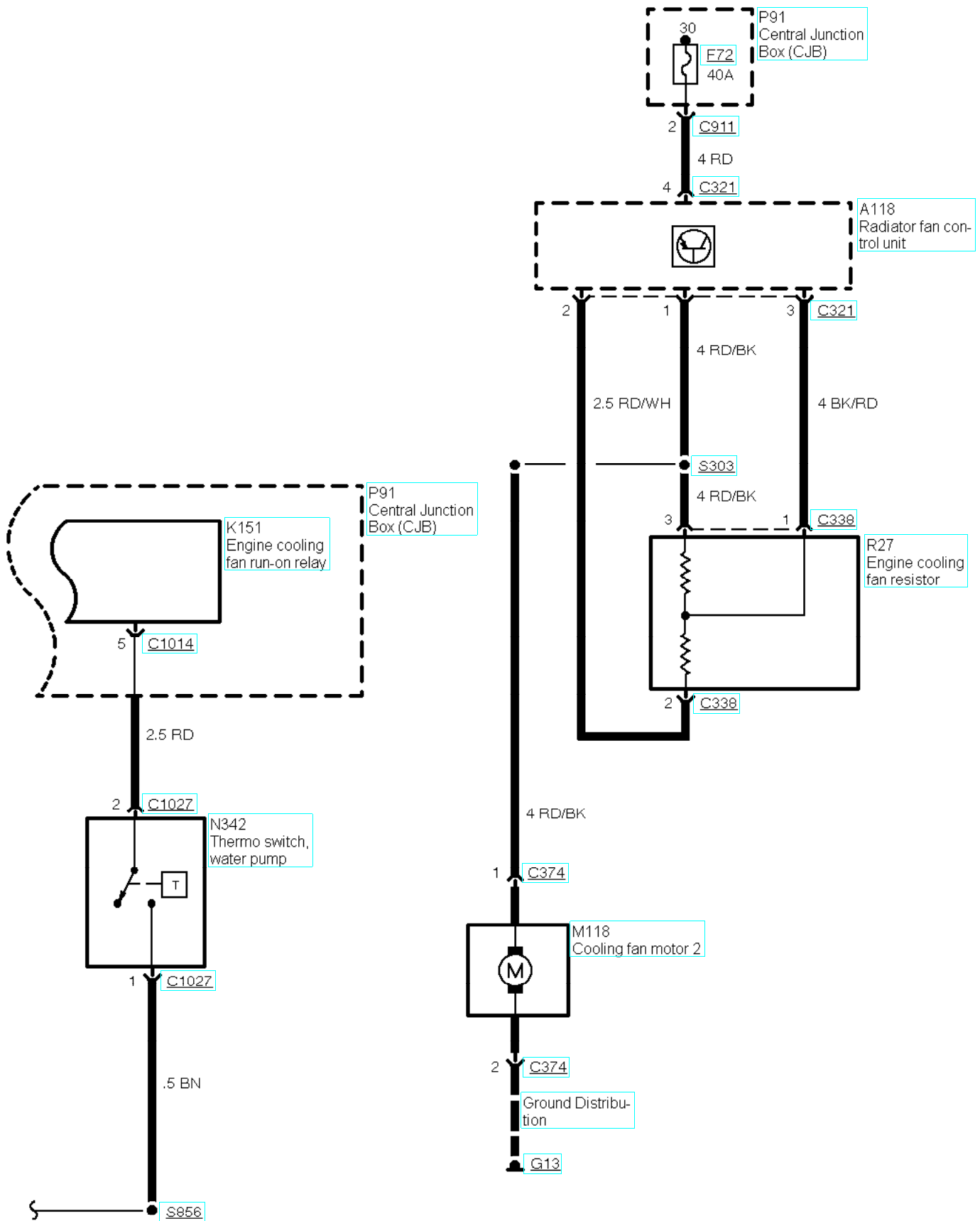

34-02-035, Air Conditioning, 1,9 TDI unit injector engine, not tropical area



34-02-036, Air Conditioning, 1,9 TDI unit injector engine, not tropical area

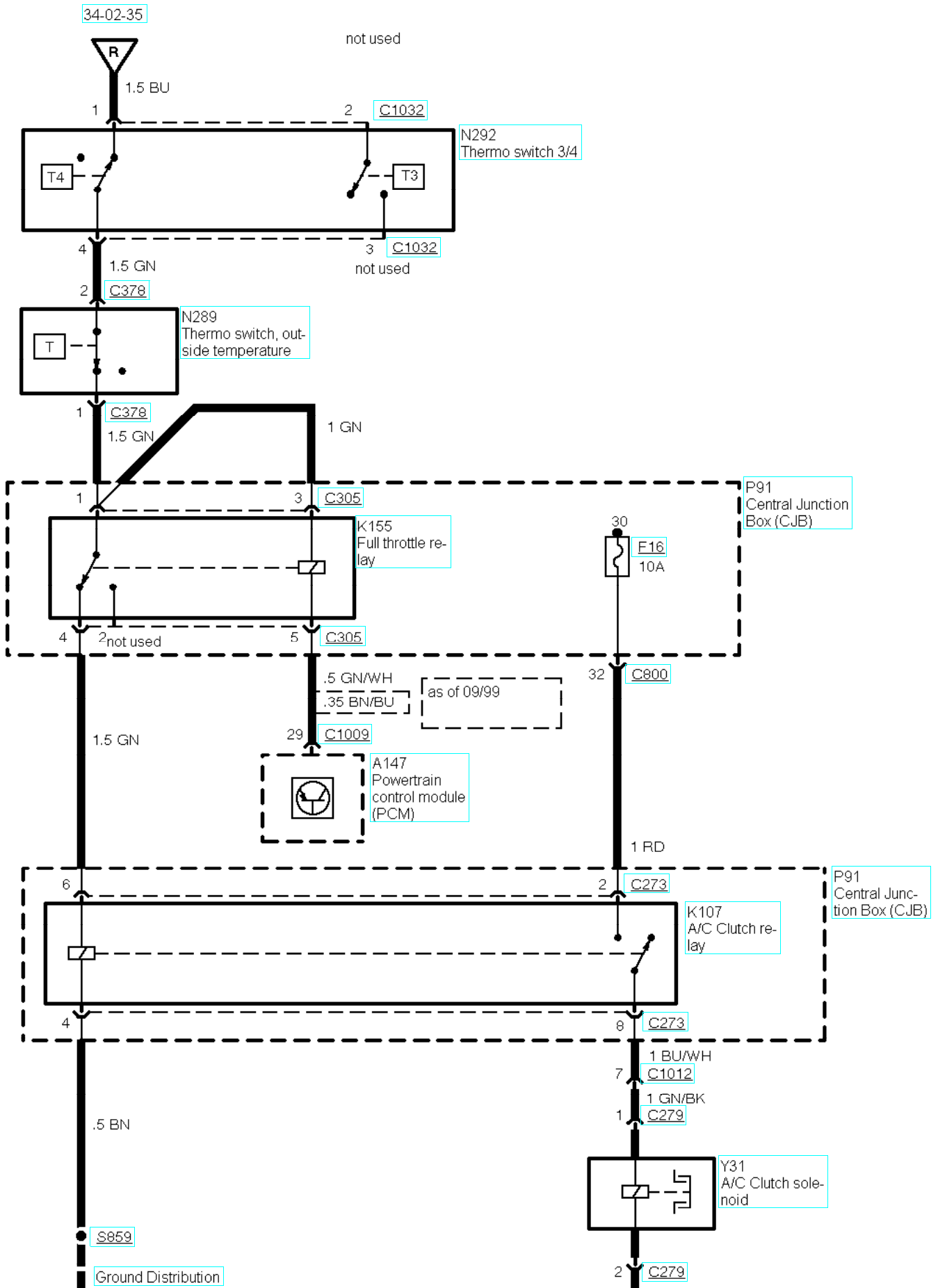

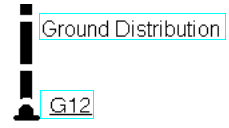

34-02-037, Air Conditioning, 1,9 TDI unit injector engine, not tropical area

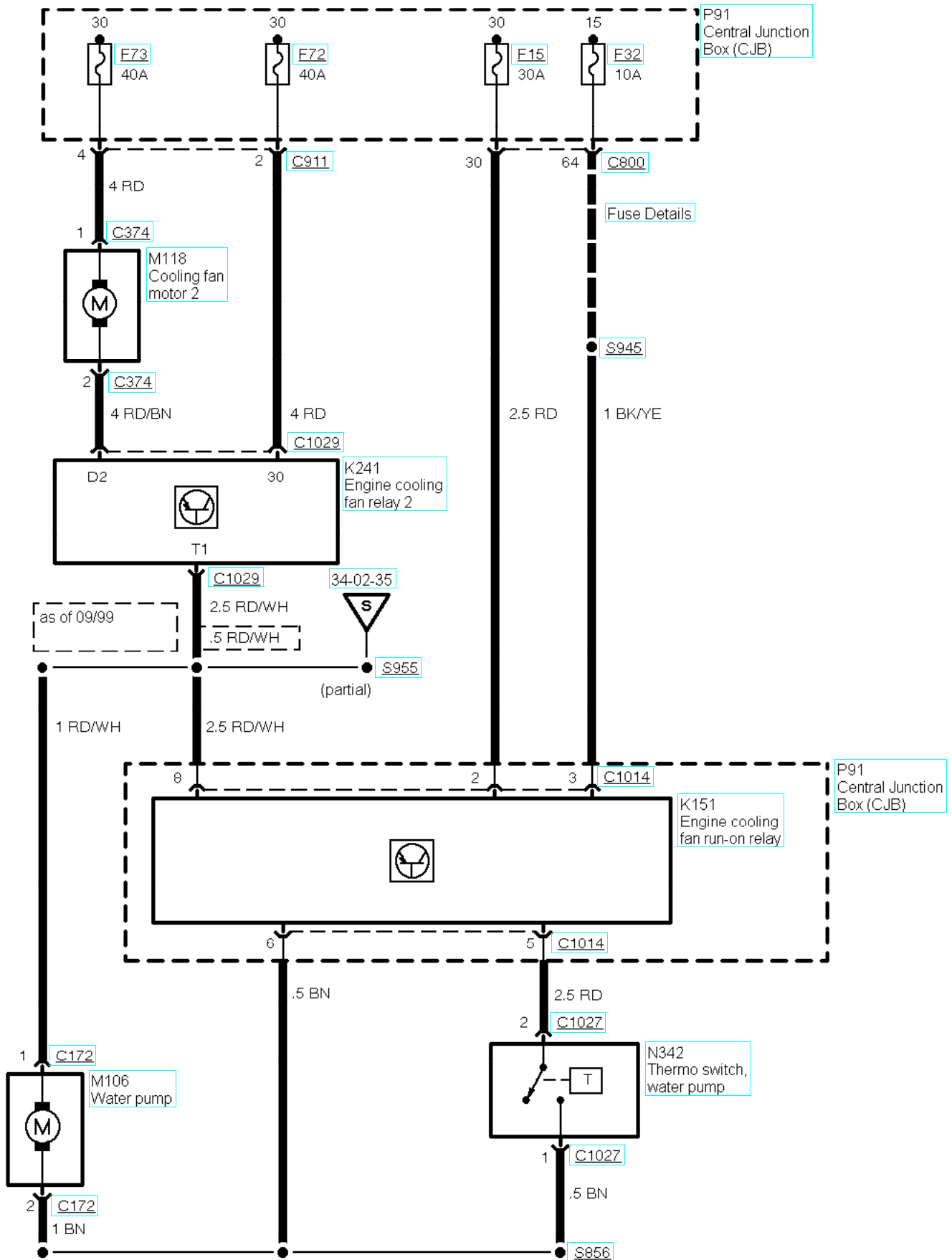

Ground Distribu-
tion

G13
